

20.50.1314.00

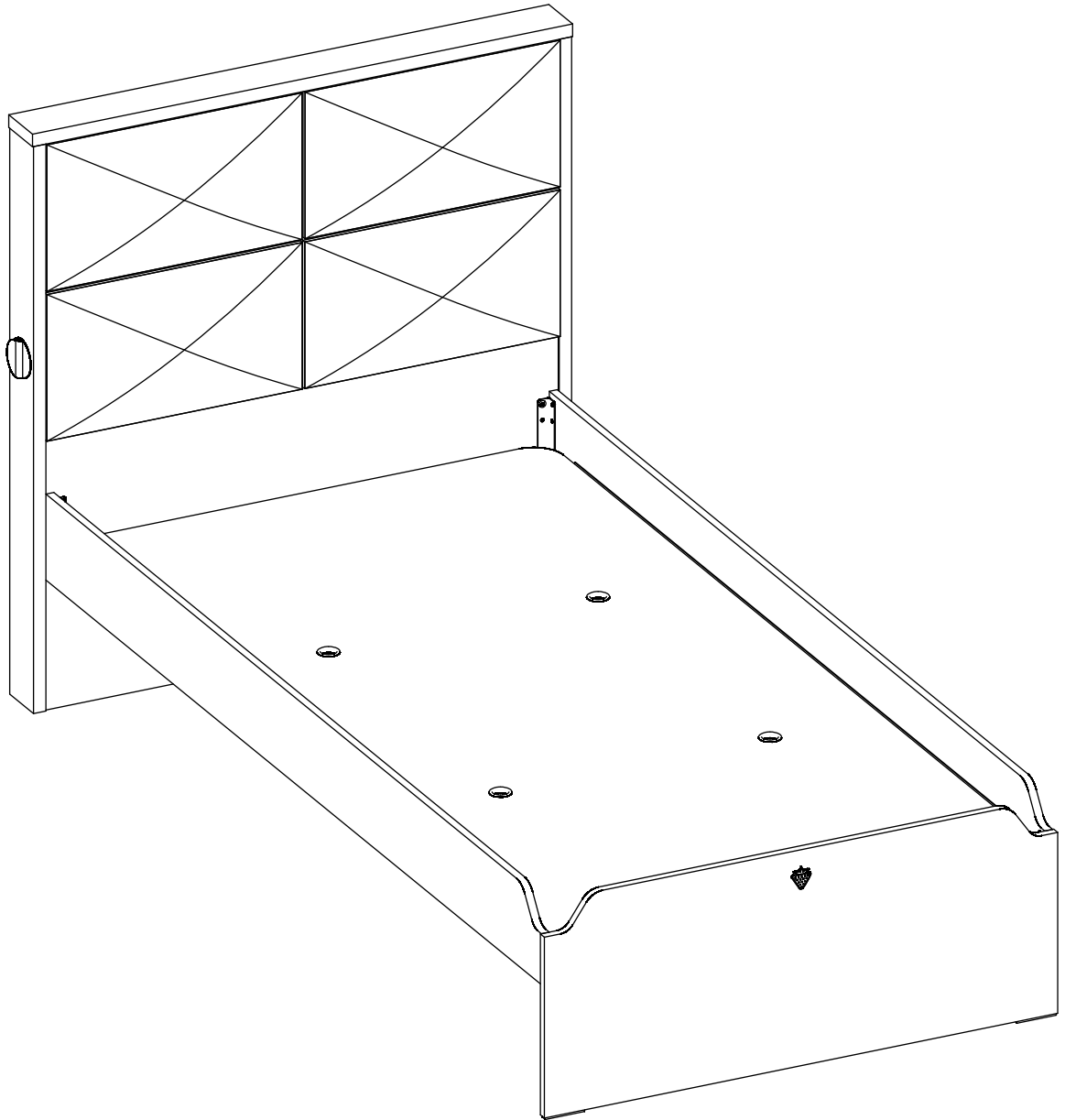

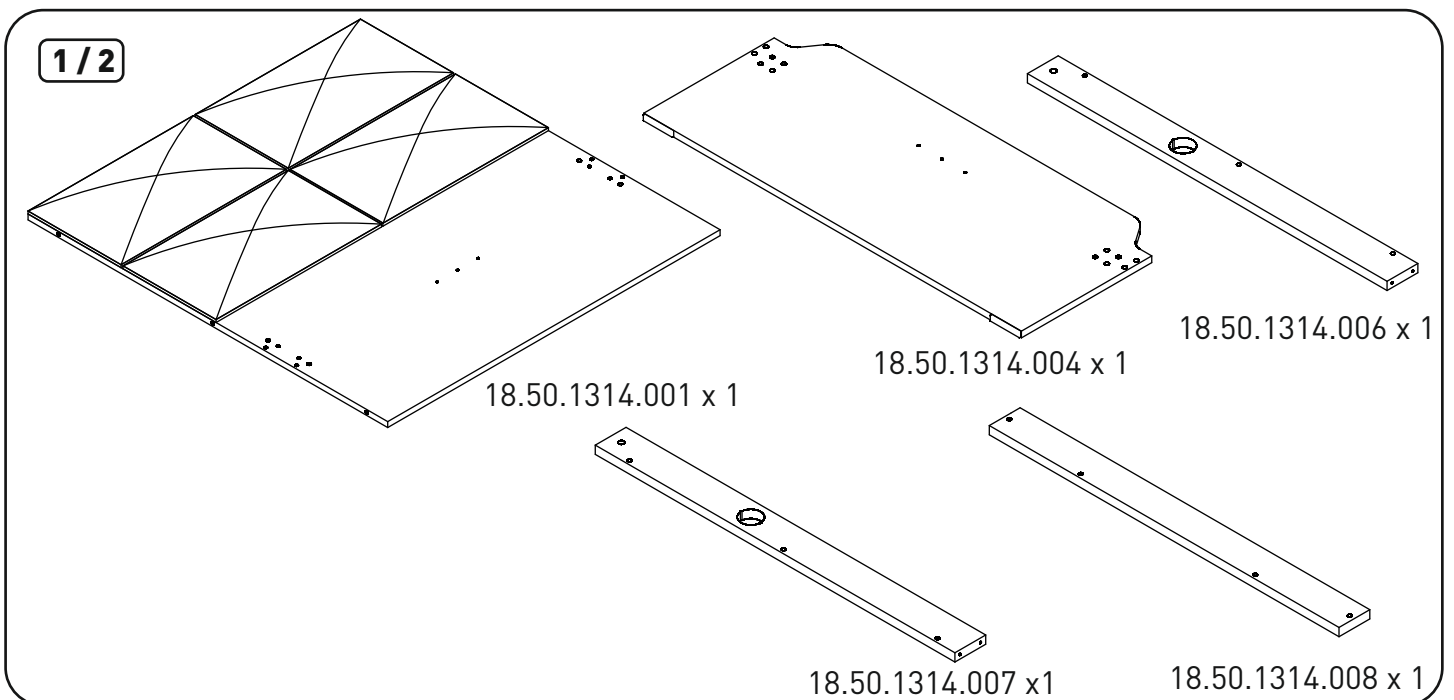

2/2

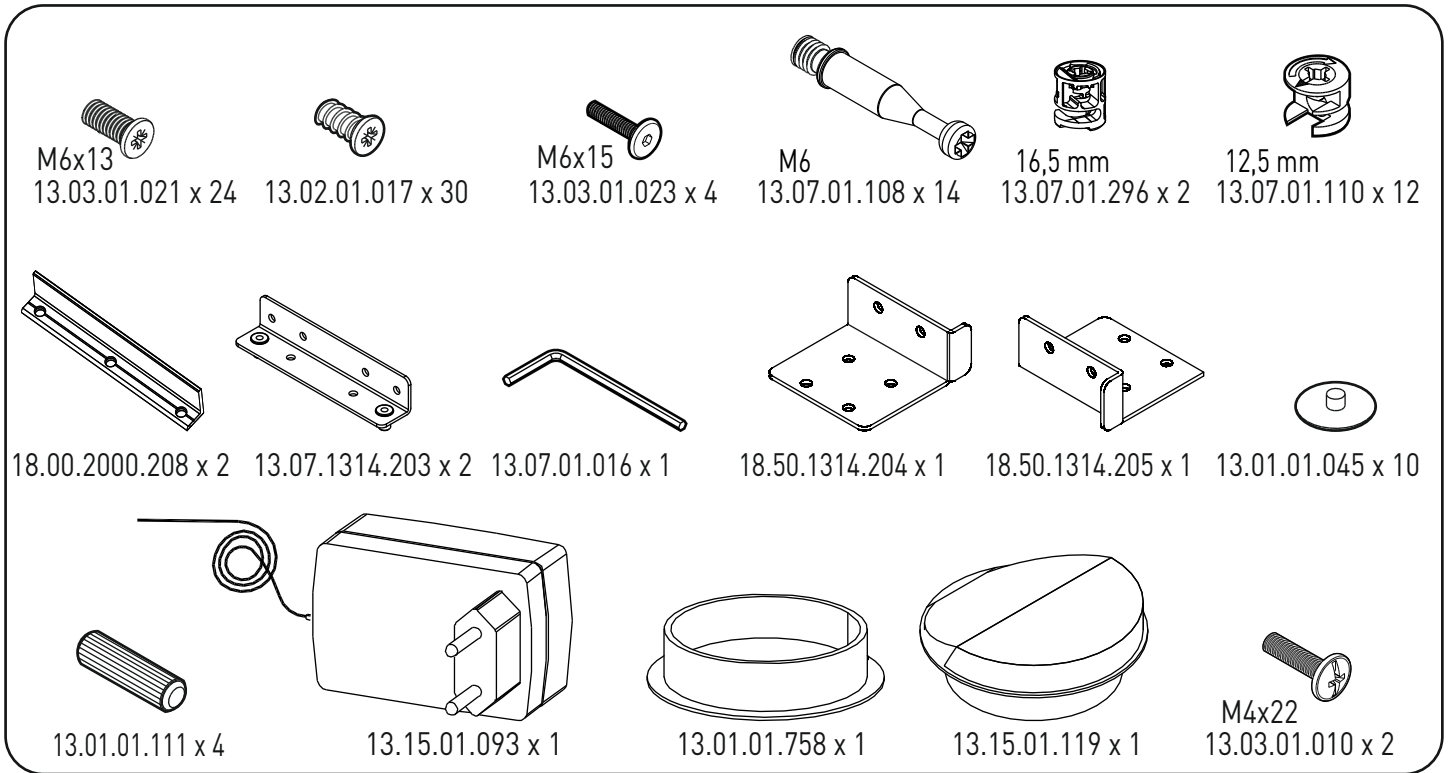
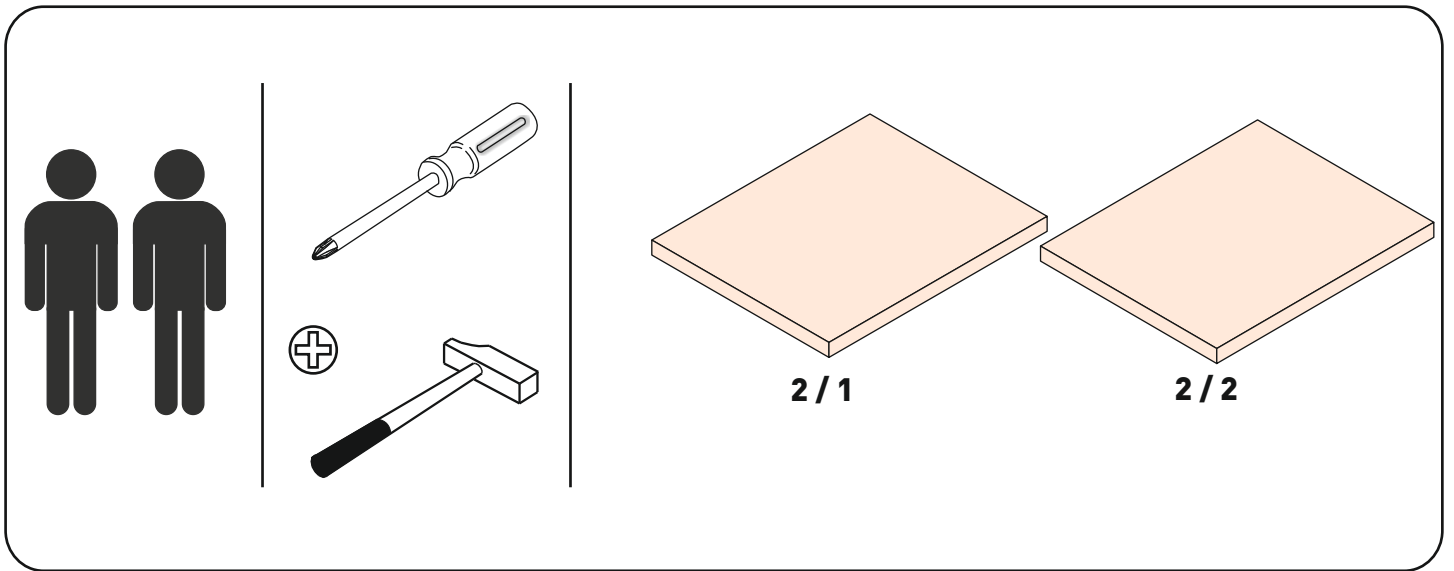
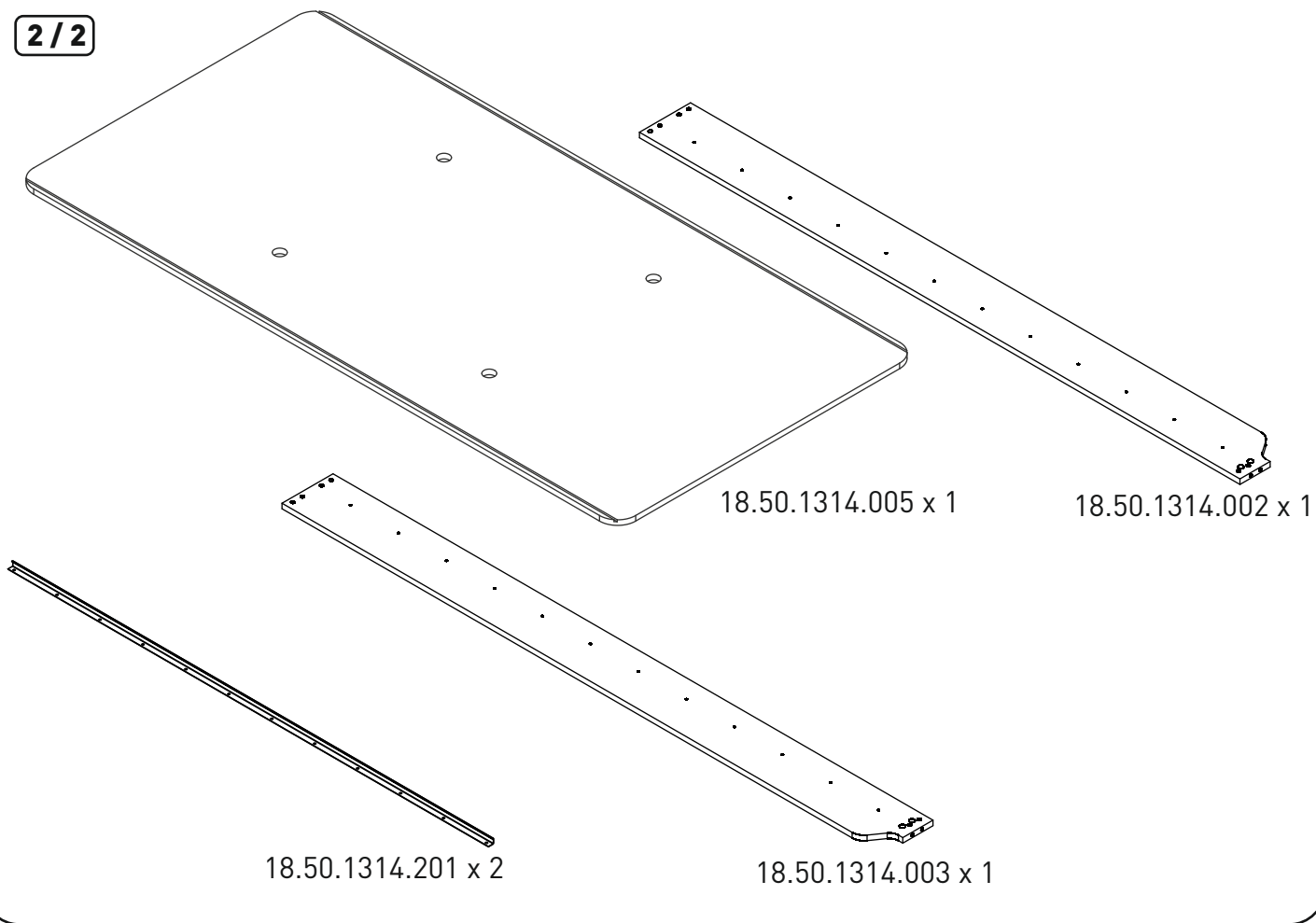

1

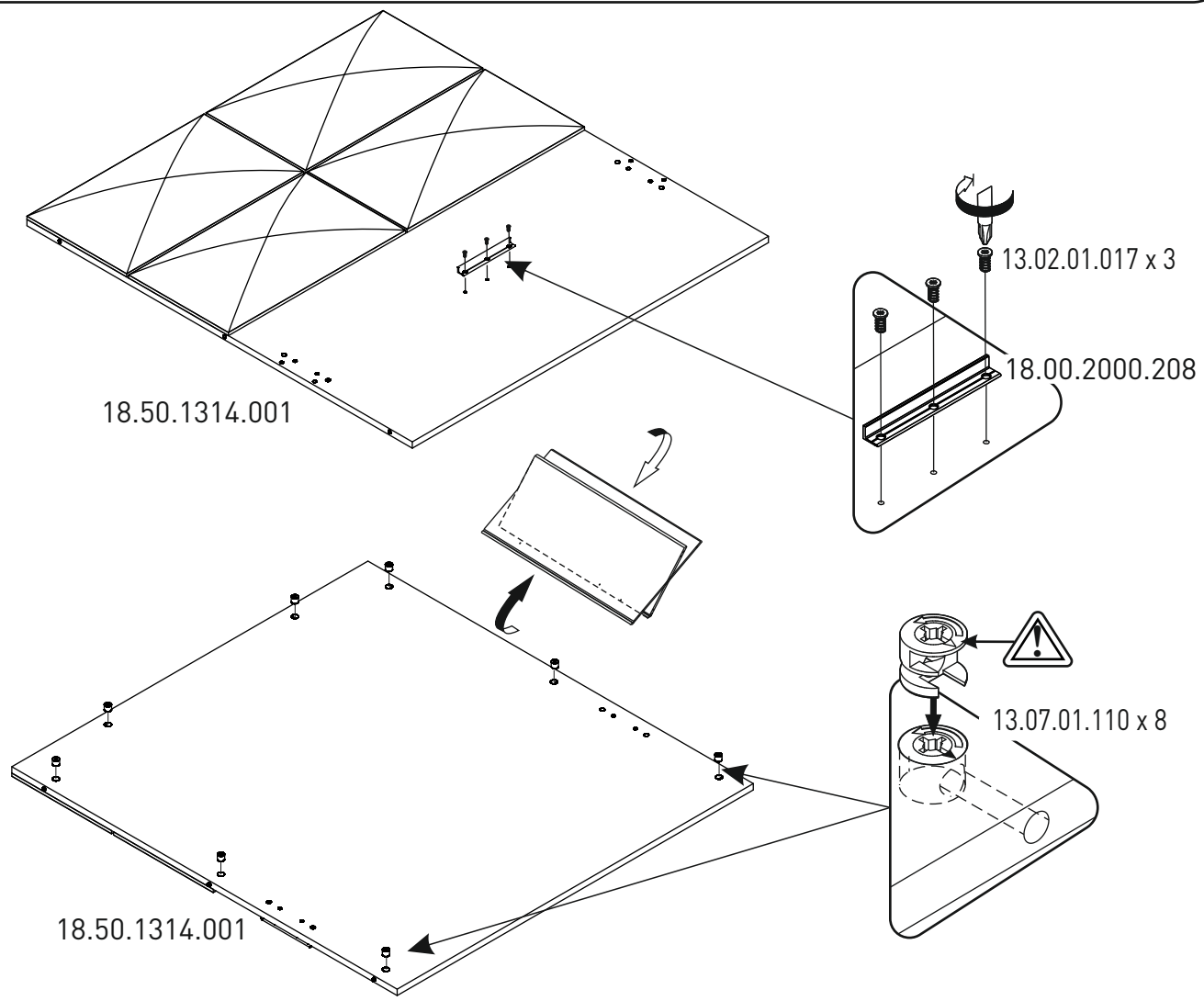

2

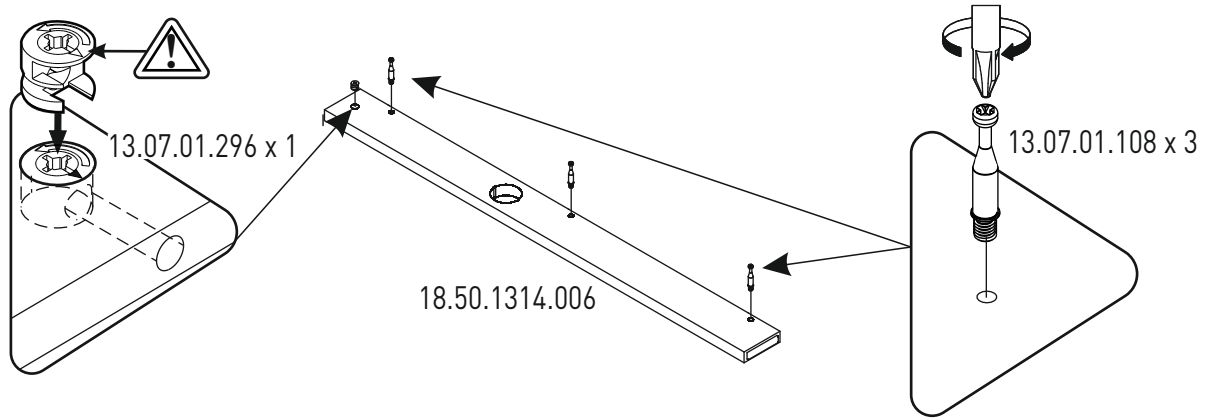

3

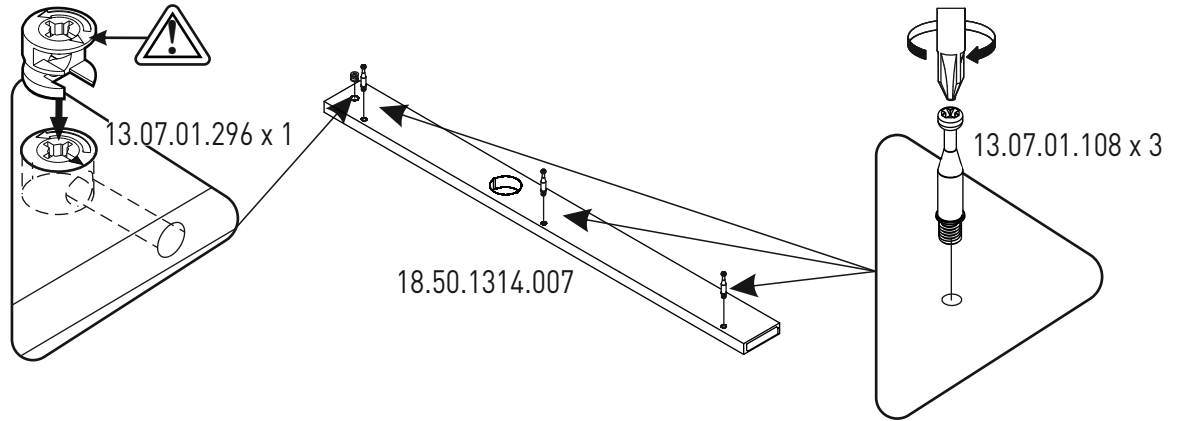

4

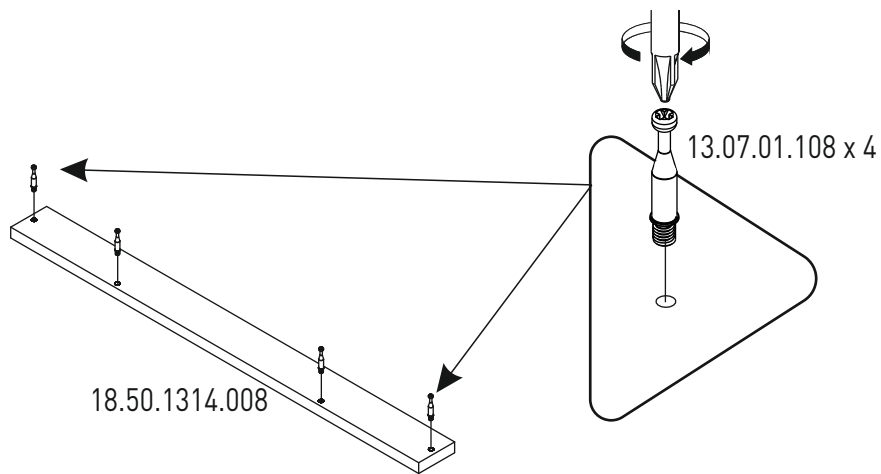

5

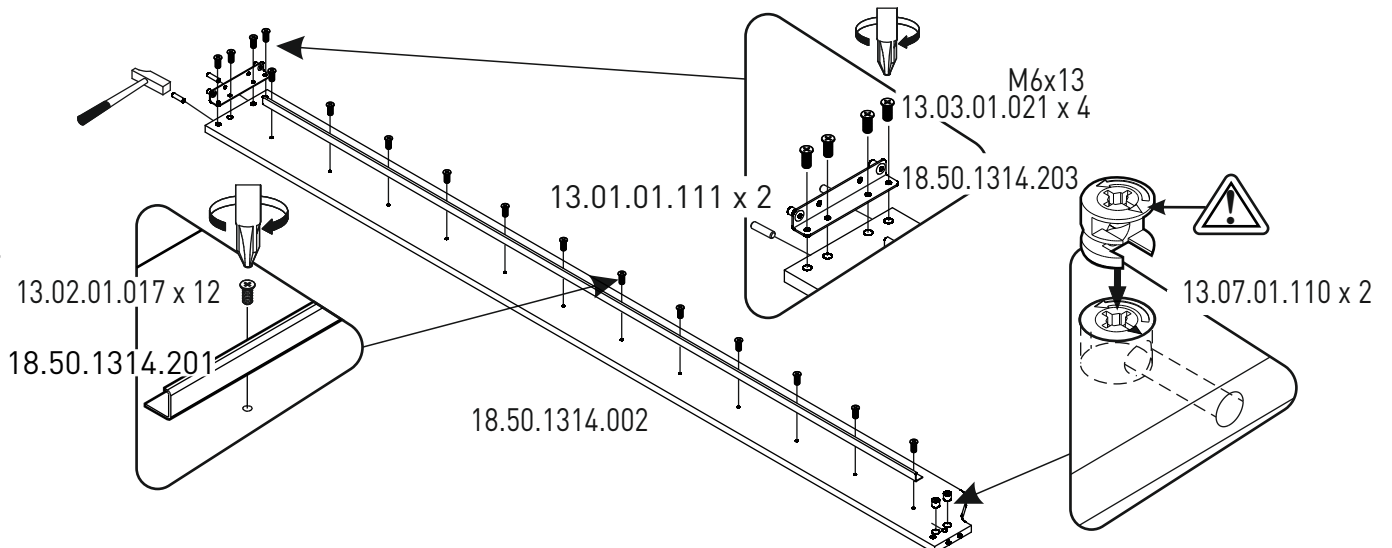

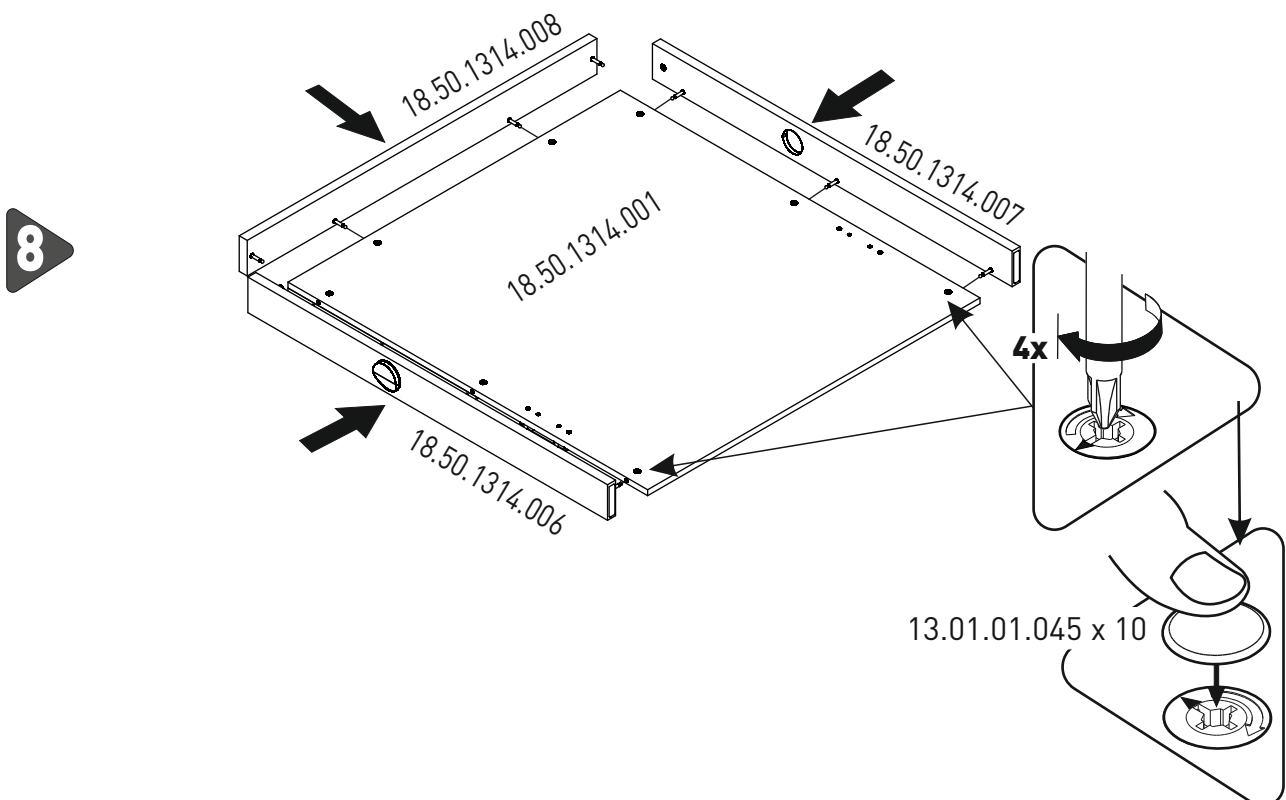
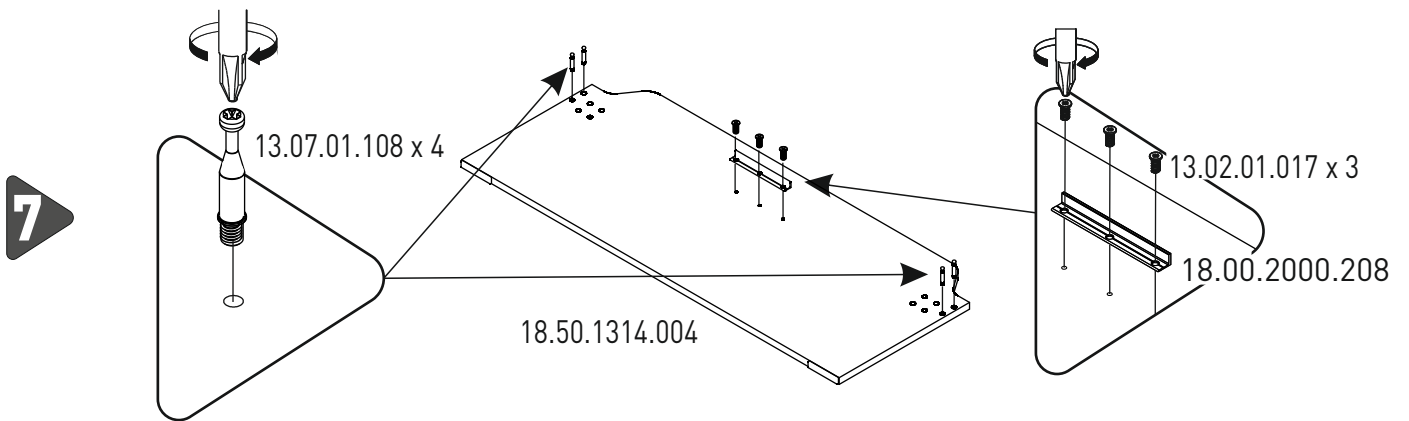
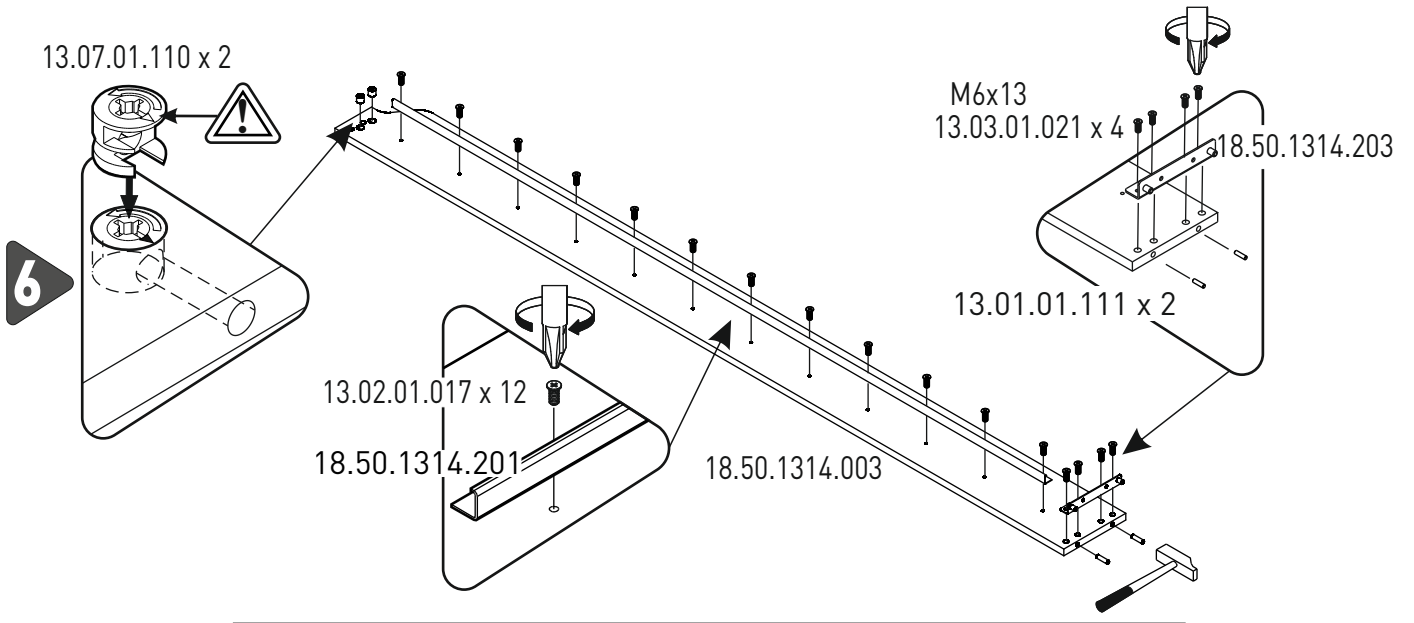

9

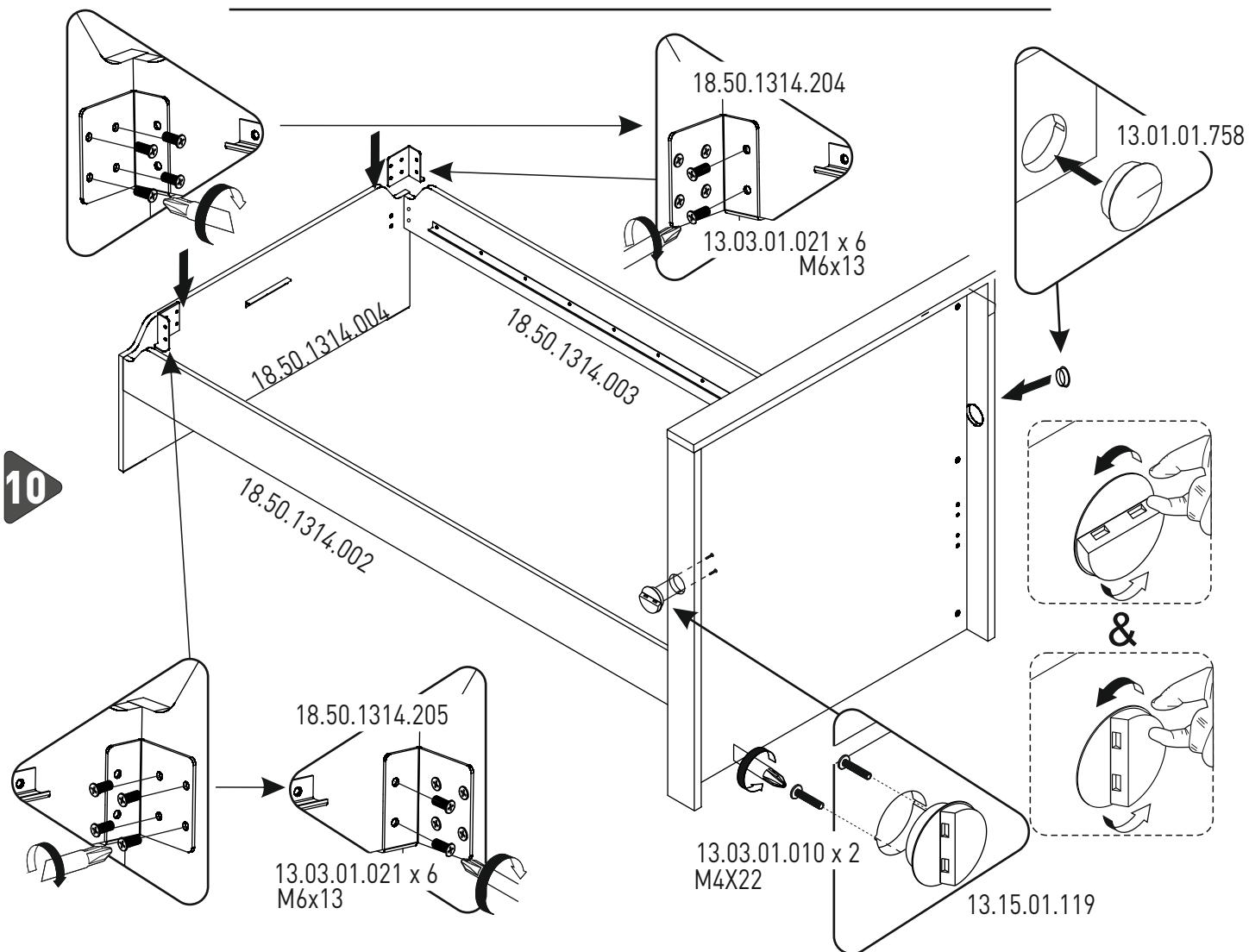
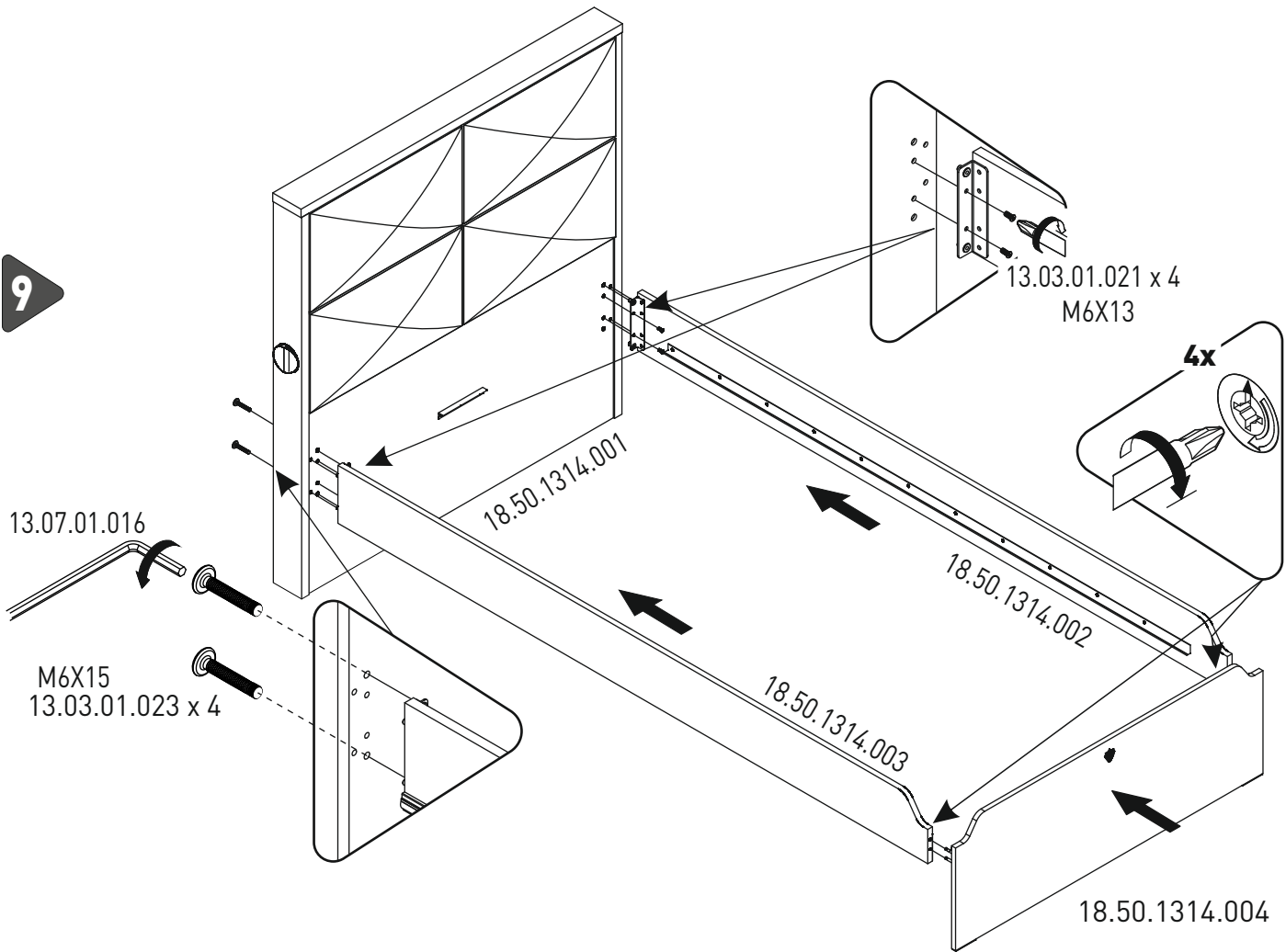

11

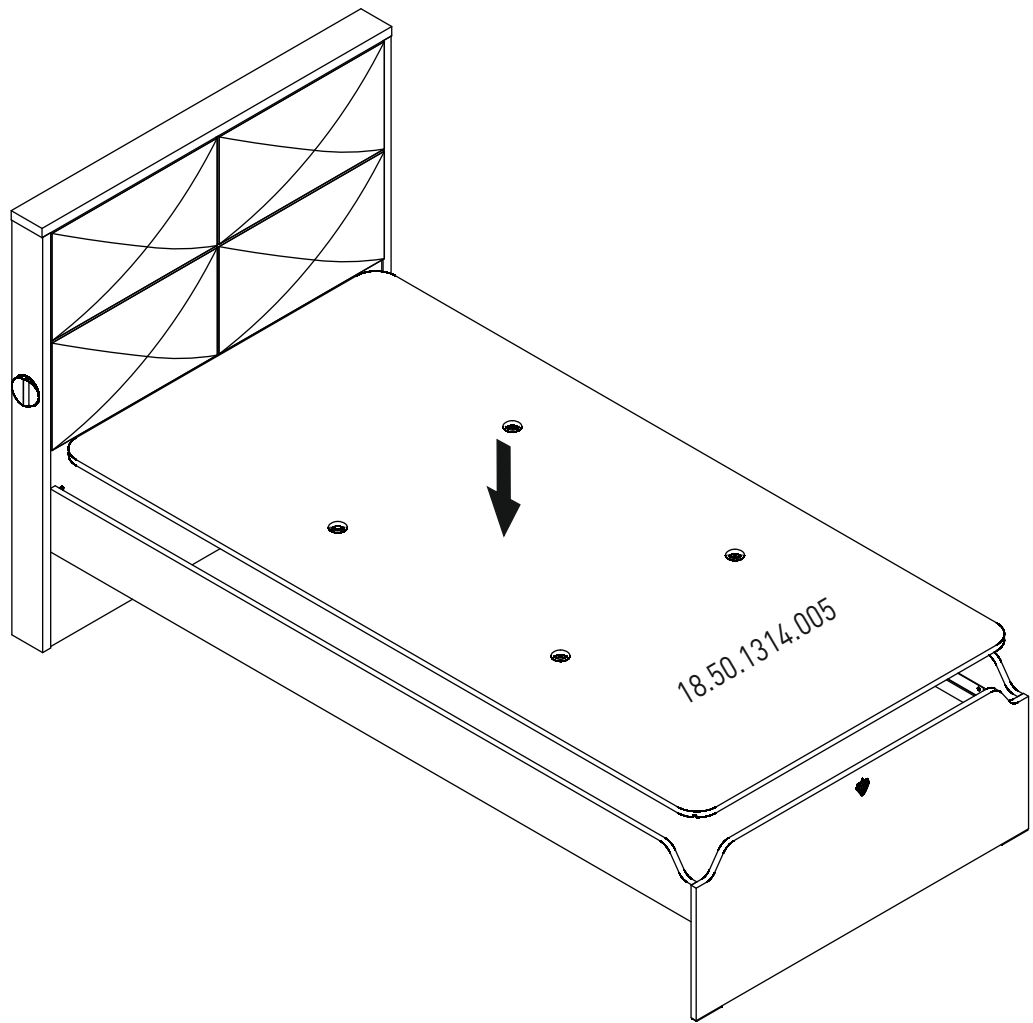

12

