

20.50.1403.00

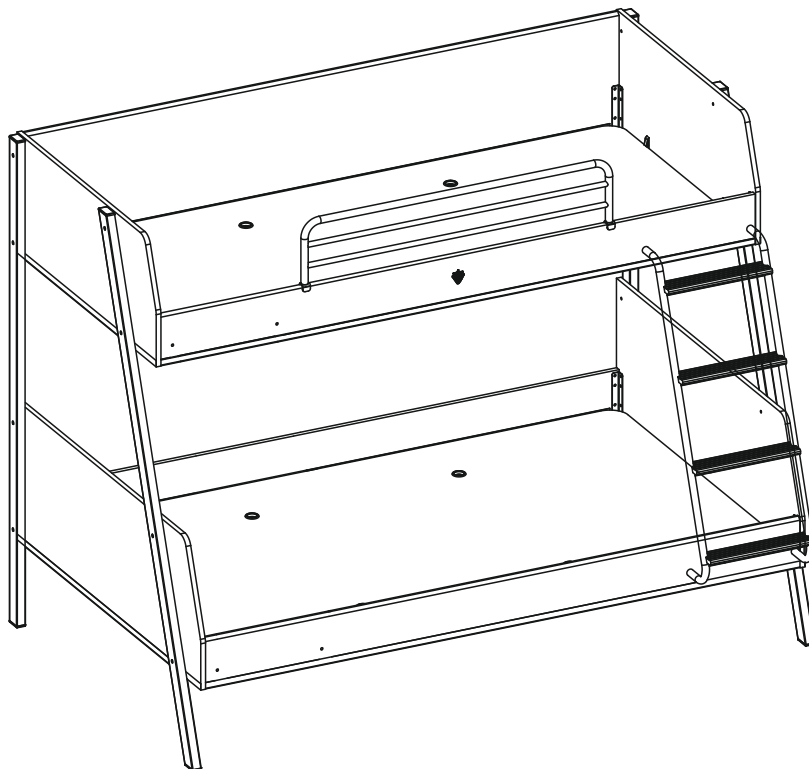

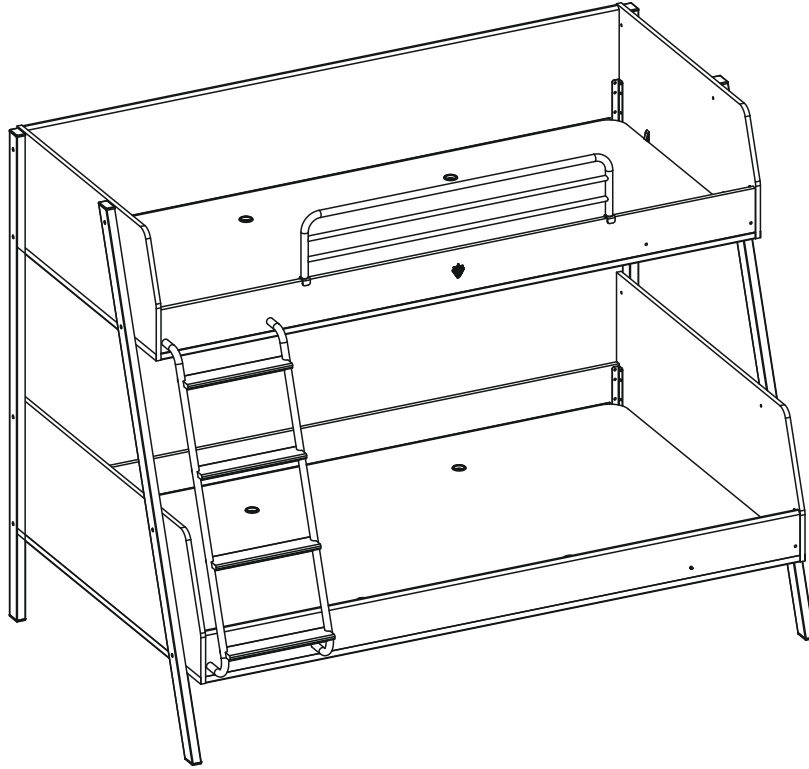

5 / 1

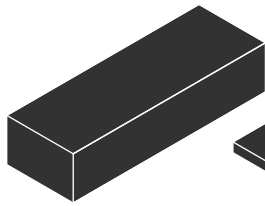
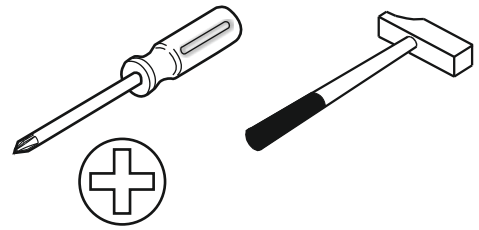
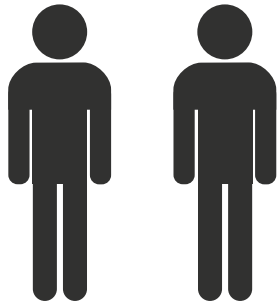
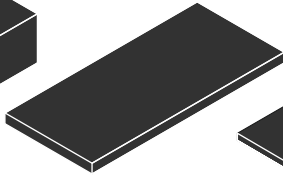

5 / 2

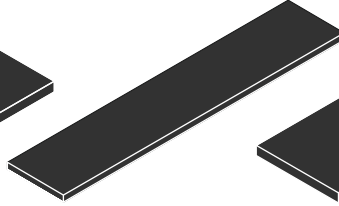

5 / 3

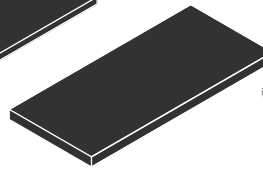

5 / 4

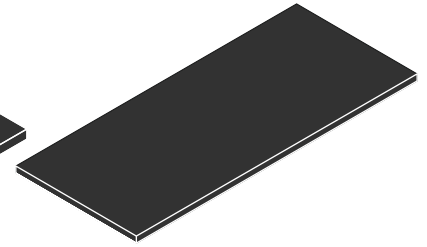

5 / 5



13.07.01.110 x 2

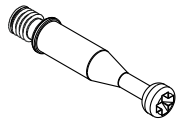

13.07.01.108 x 2

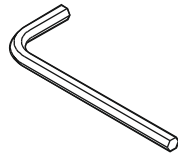

13.07.01.016 x 1



M6X13
13.03.01.021 x 56

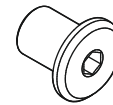

13.07.01.093 x 16



13.02.01.017 x 54

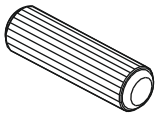

13.01.01.111 x 4



13.01.01.045 x 2



13.01.02.140 x 4



M6x15
13.03.01.023 x 4

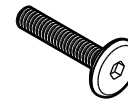

M6x30
13.03.01.029 x 4

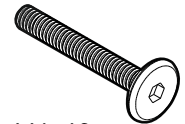

M6x40
13.03.01.035 x 16

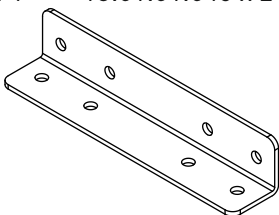

18.00.2000.211 x 8

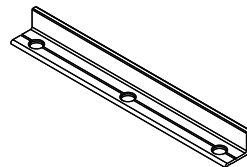

18.00.2000.208 x 2

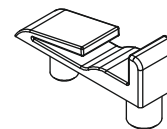

13.01.01.773 x 4

5 / 1

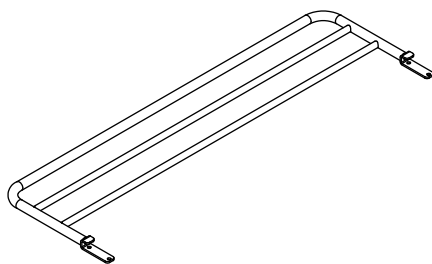

18.50.1403.206 x 1

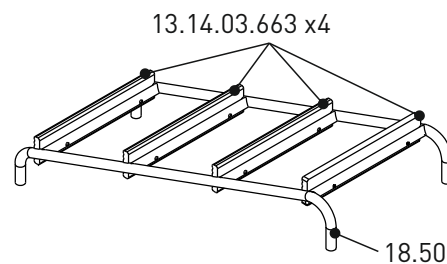

18.50.1403.012 x 1

13.14.03.663 x 4

18.50.1403.204

5/2

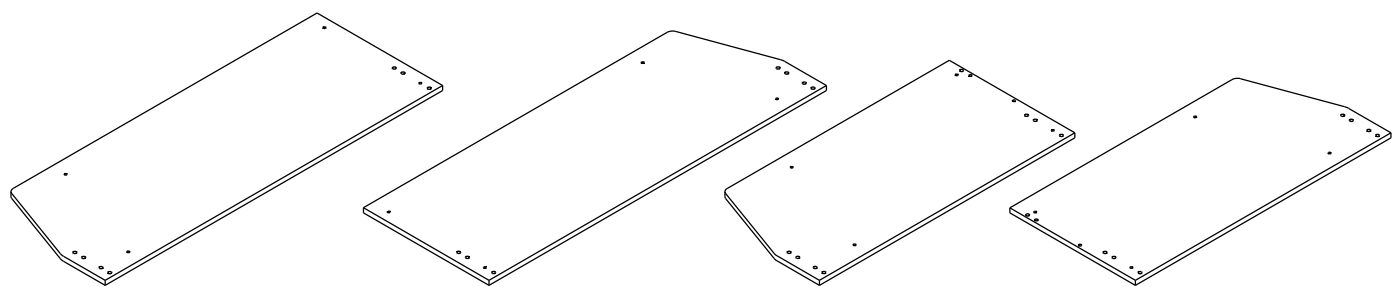

18.50.1403.001 x1

18.50.1403.002 x1

18.50.1403.006 x1

18.50.1403.007 x1

5/3

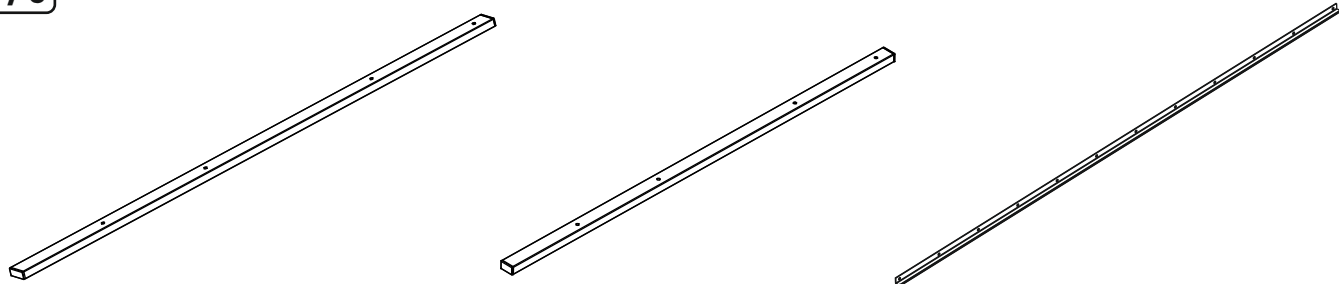

18.50.1403.201 x2

18.50.1403.202 x2

18.50.1403.207 x 4

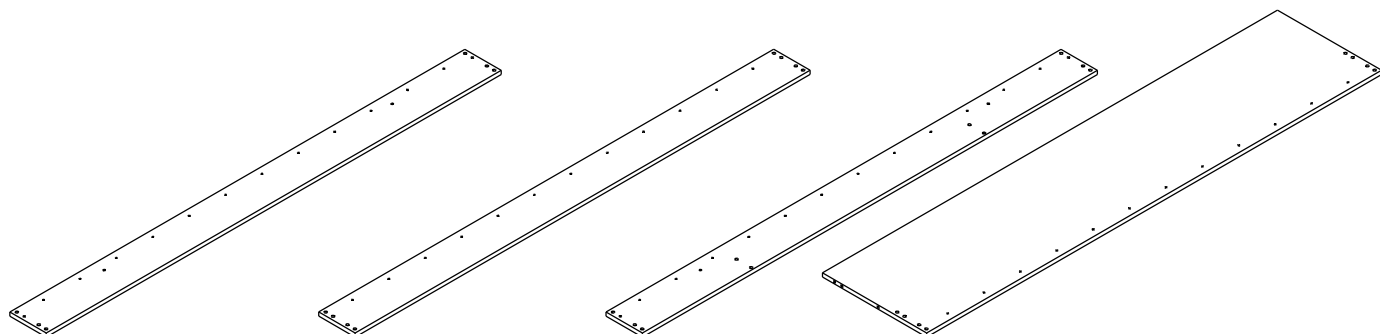

18.50.1403.004 x1

18.50.1403.003 x1

18.50.1403.005 x1

18.50.1403.008 x1

5/4

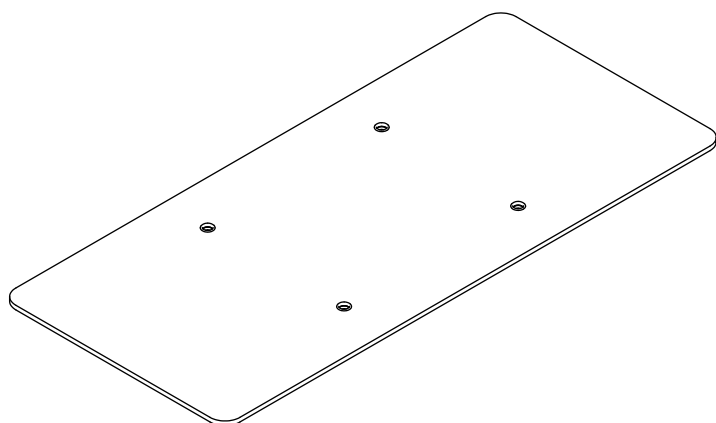

18.50.1403.009 x1

5/5

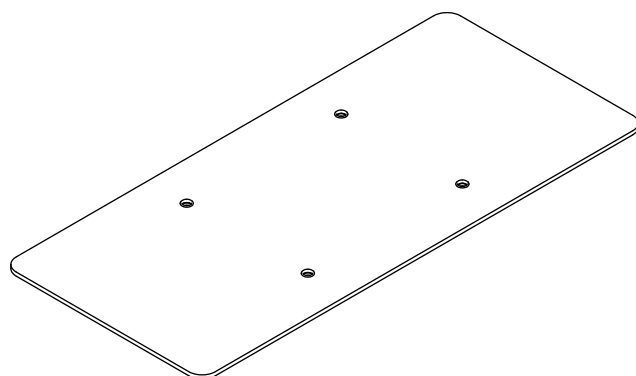

18.50.1403.010 x1

1

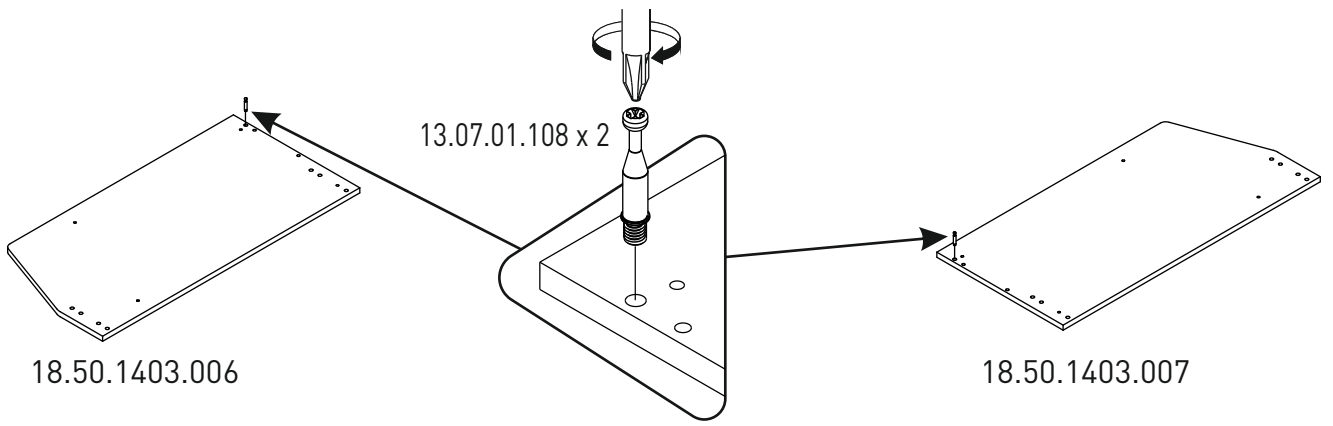

2

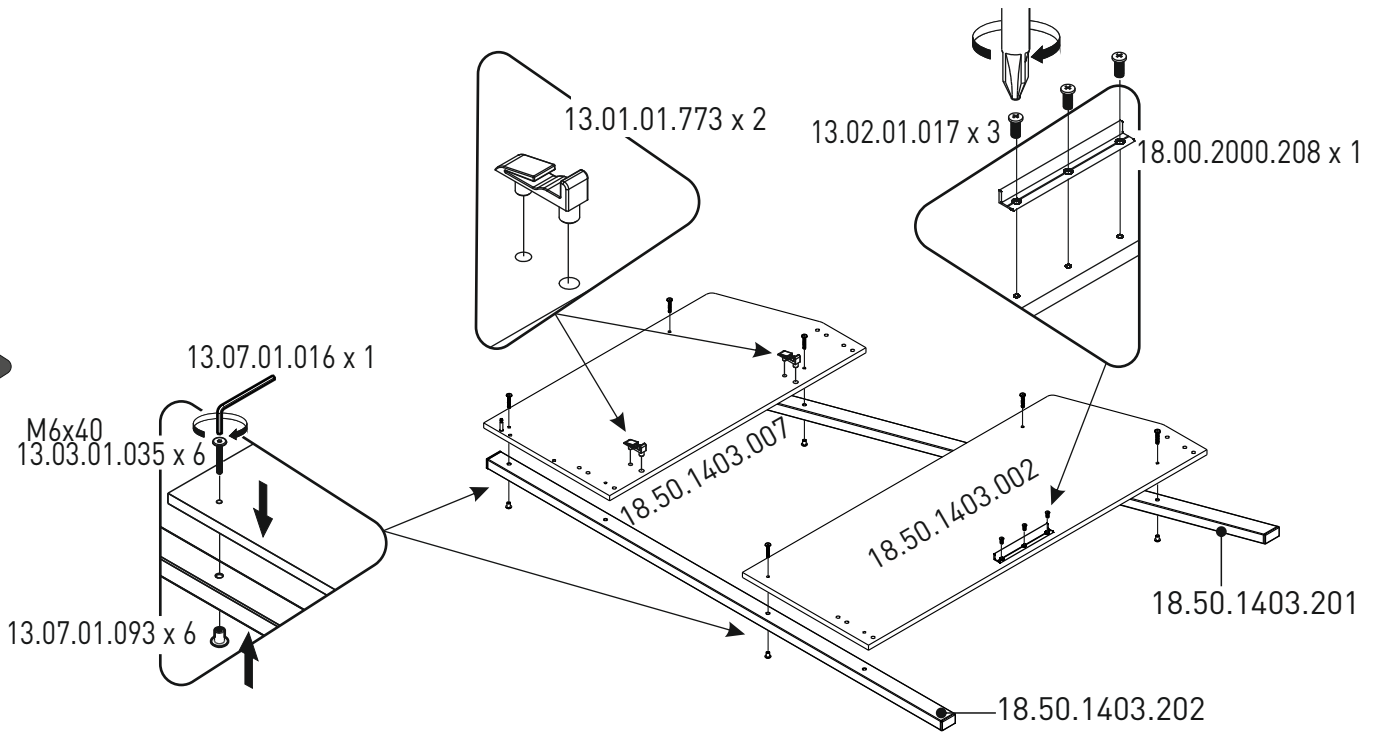

3

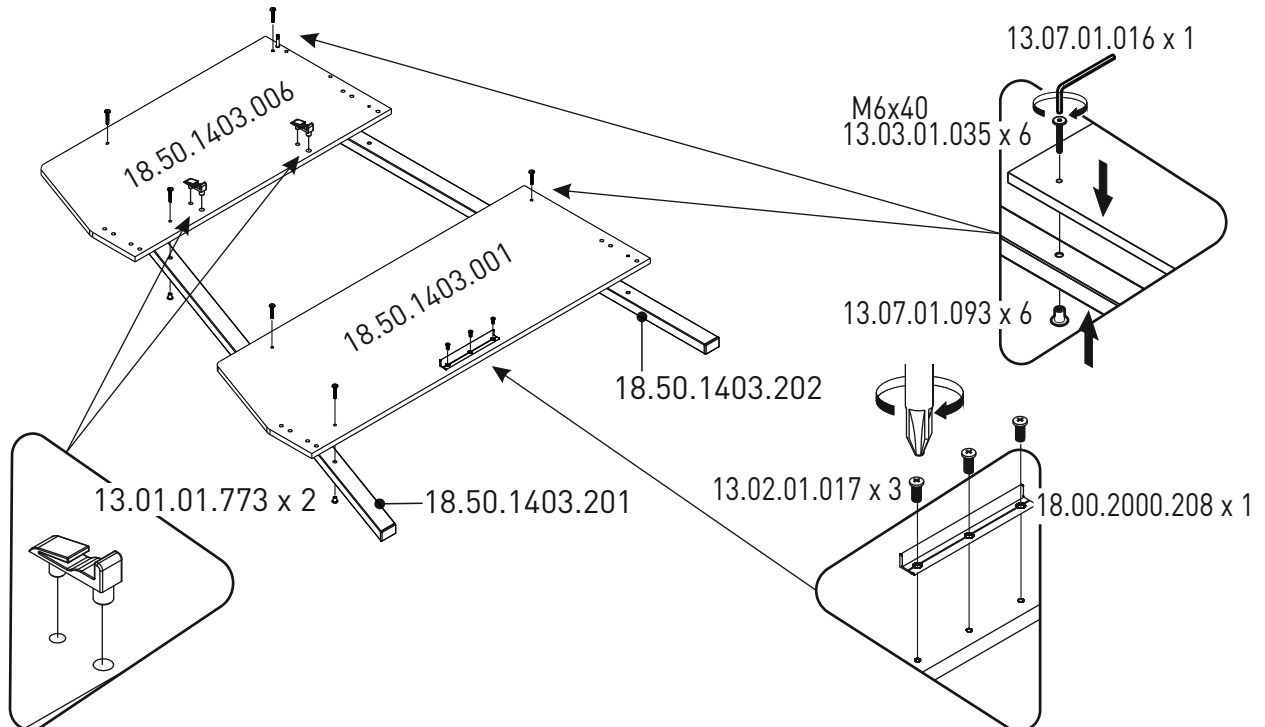

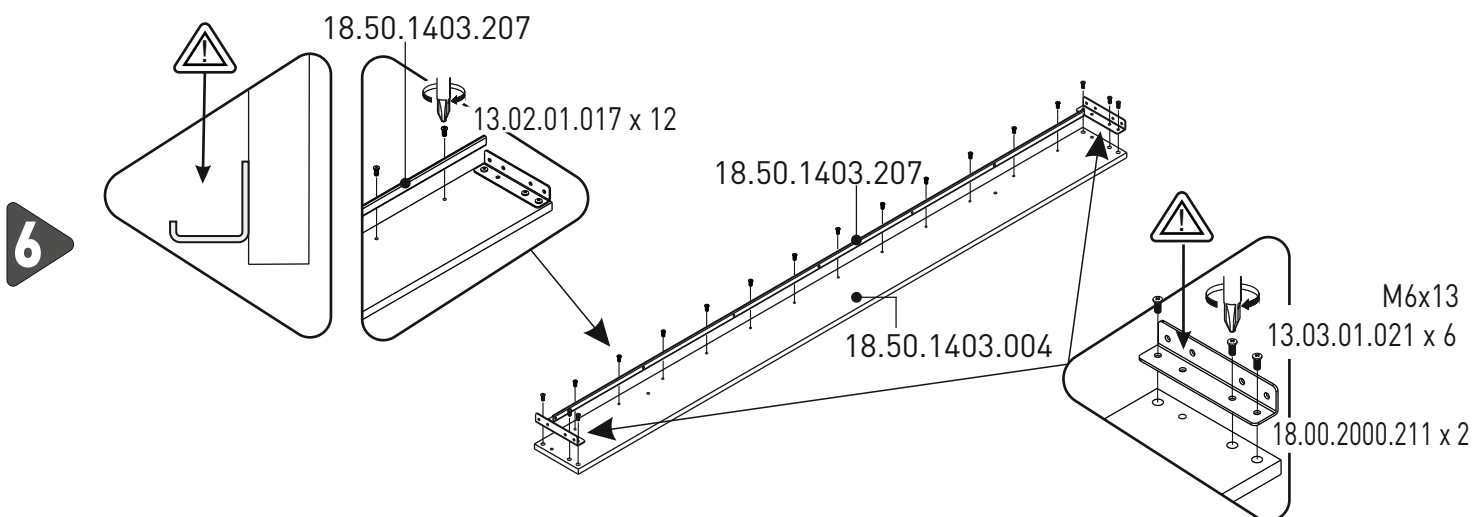
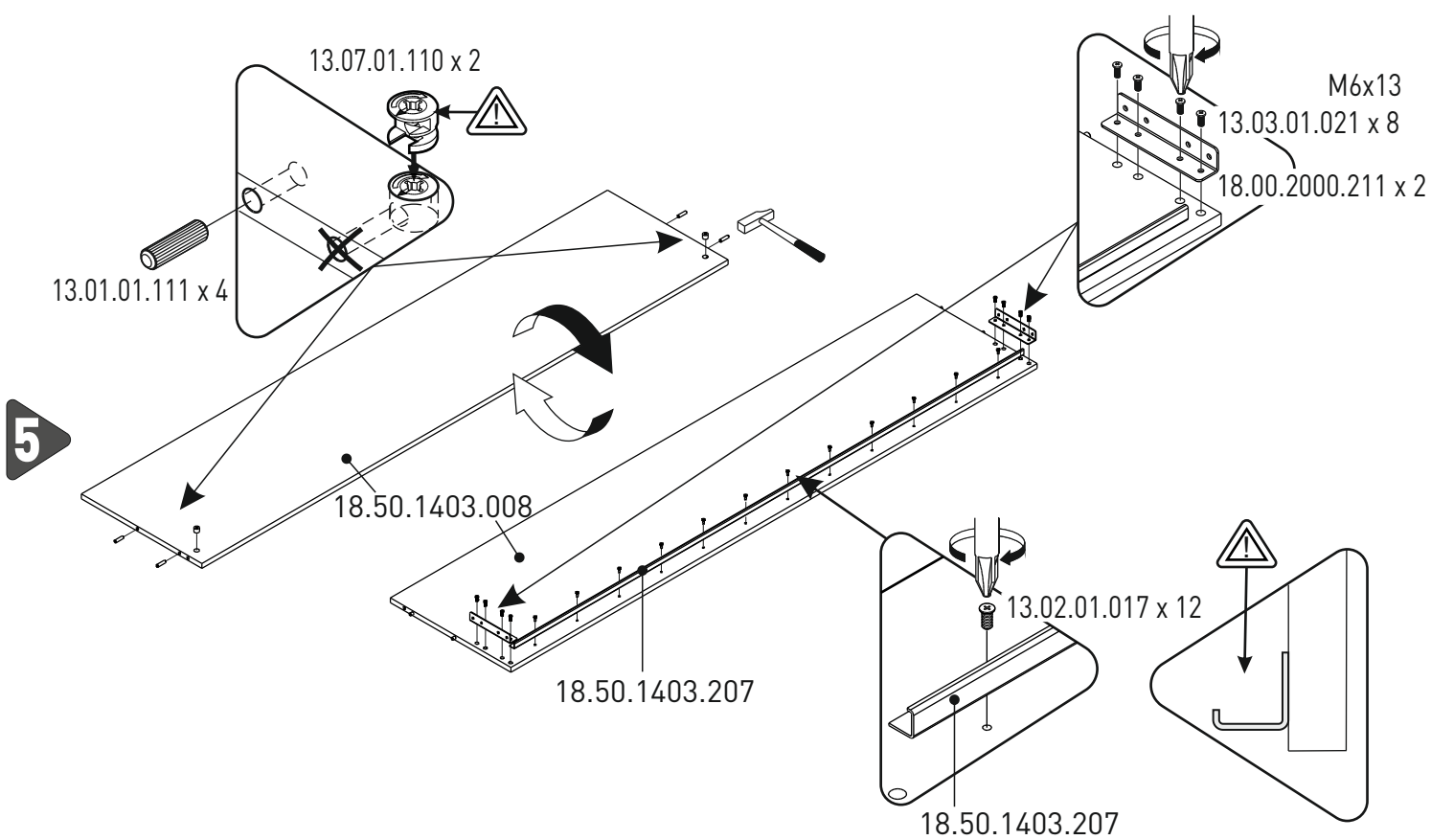
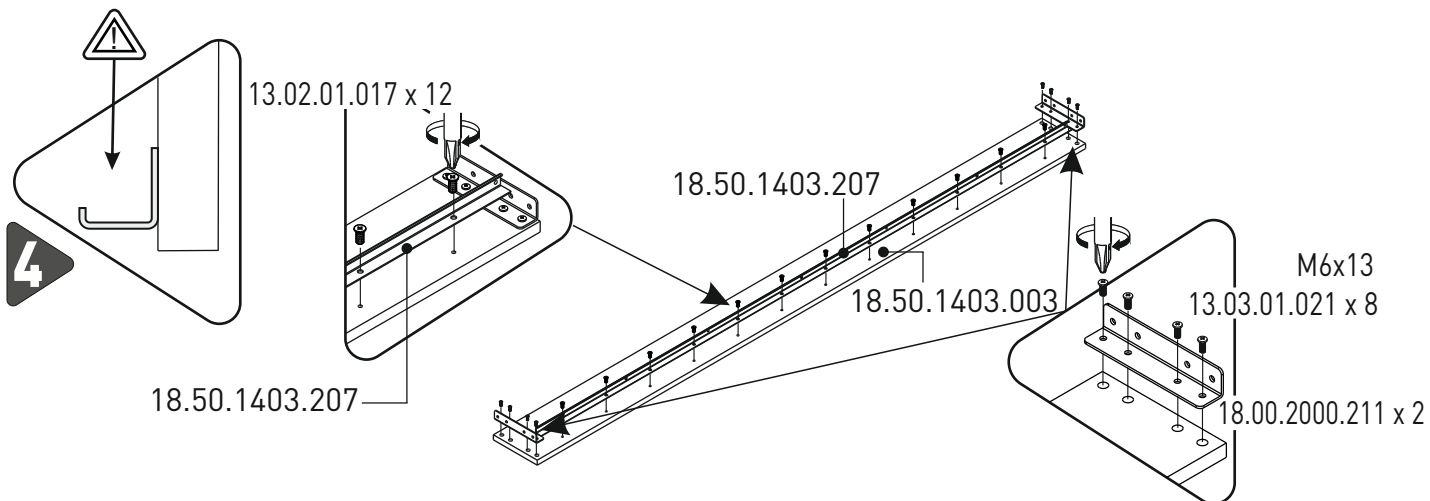

7

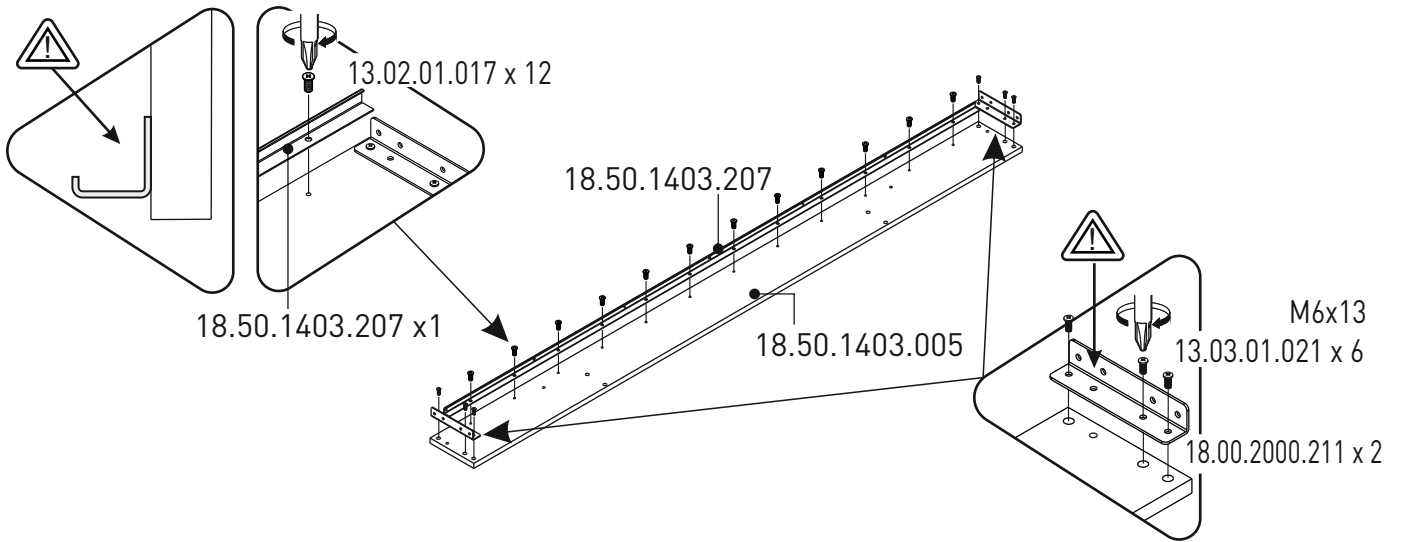

8

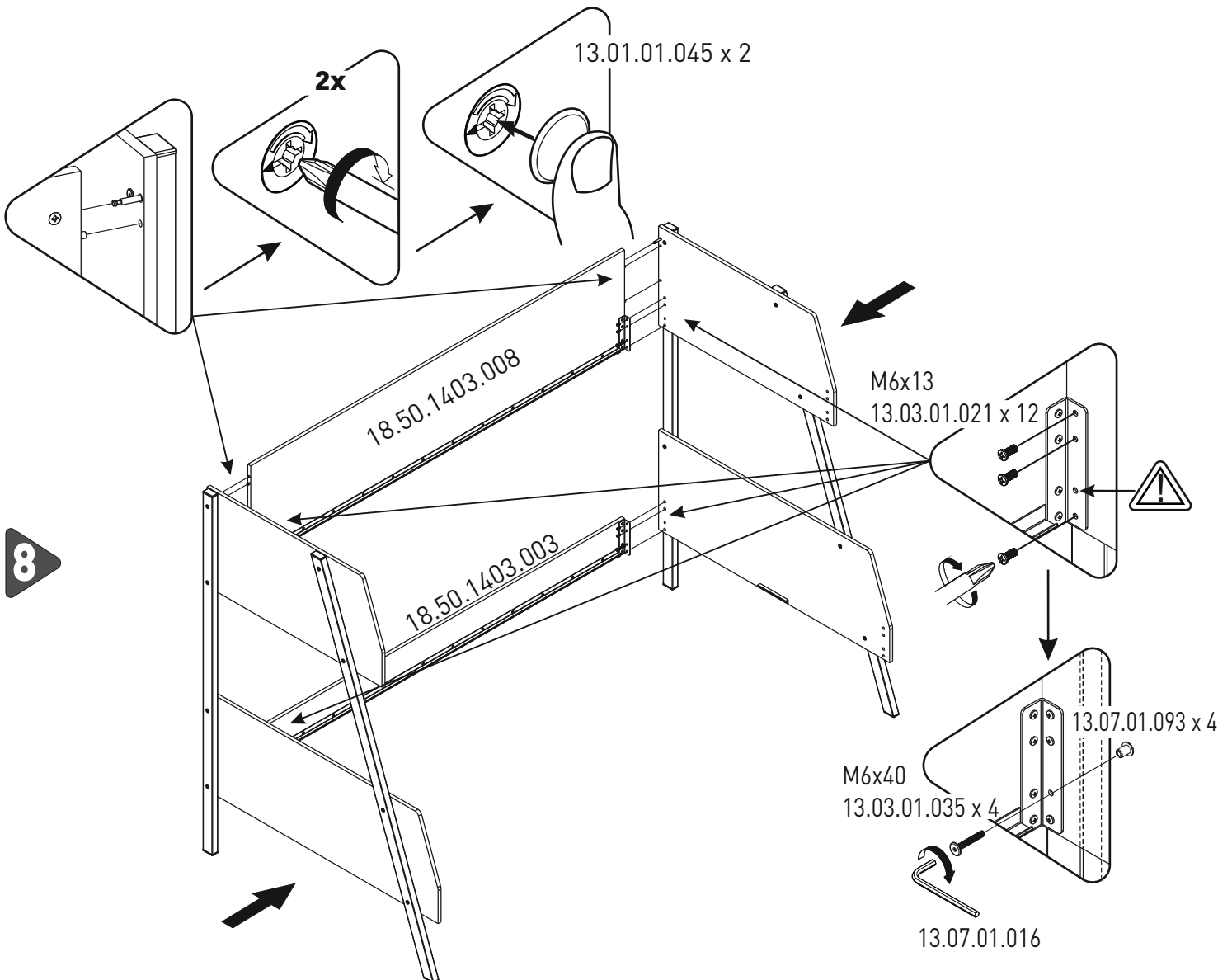

9

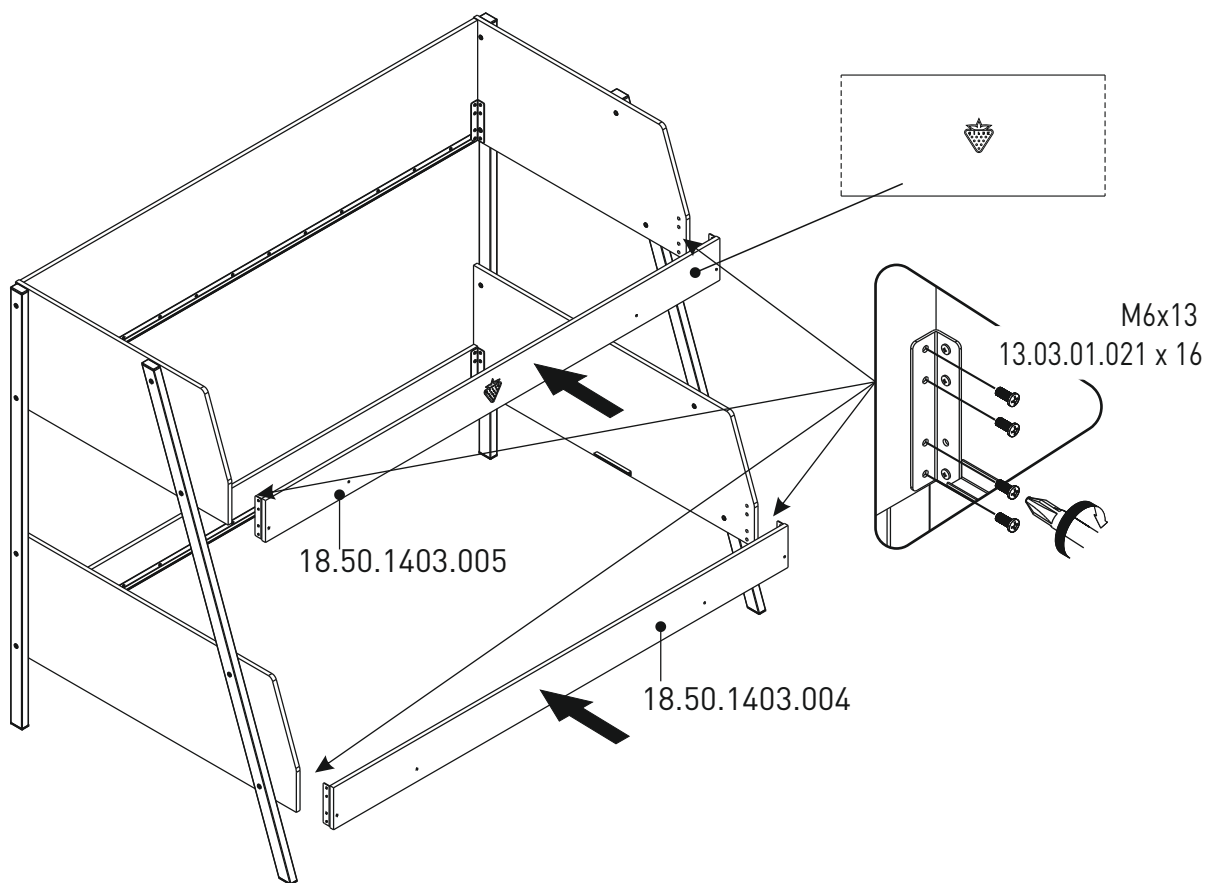

10

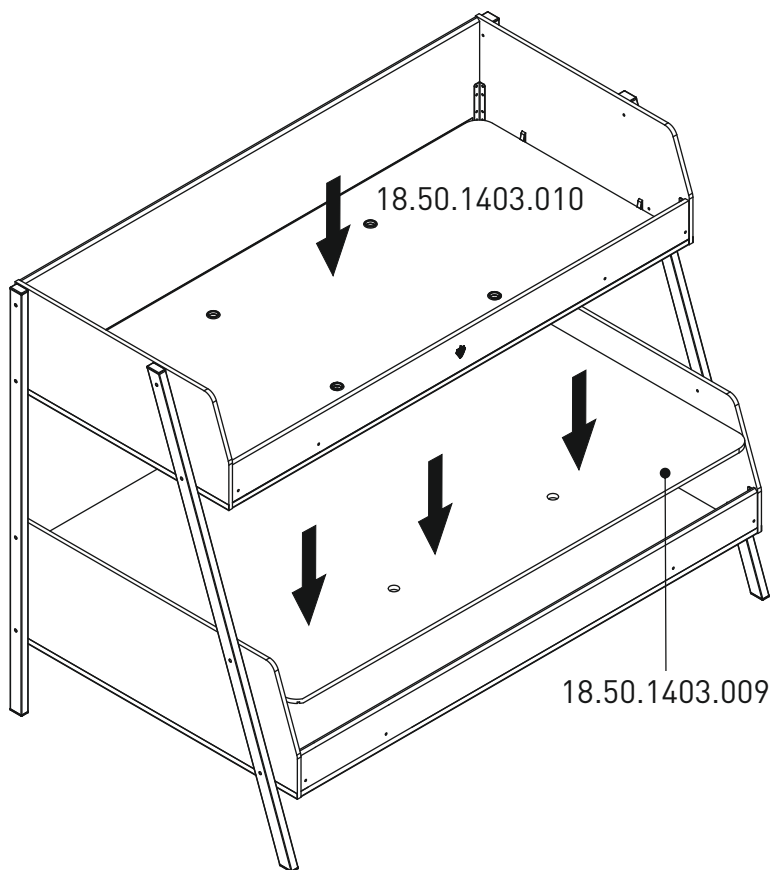

11a

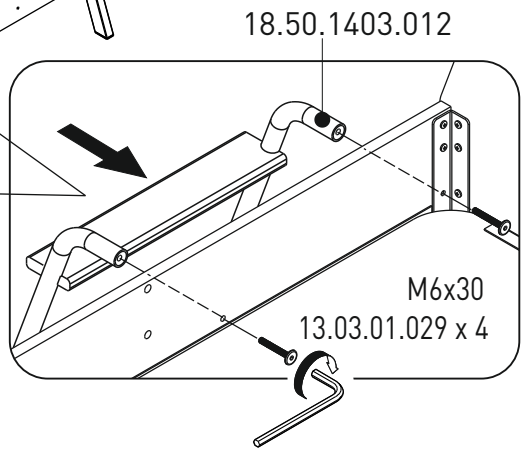
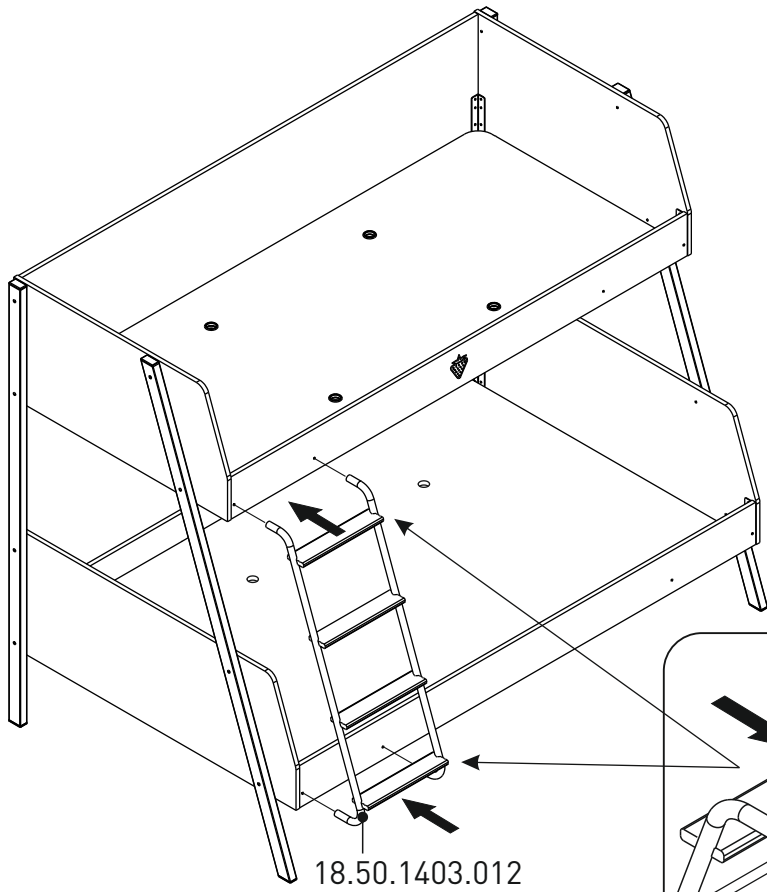

11b

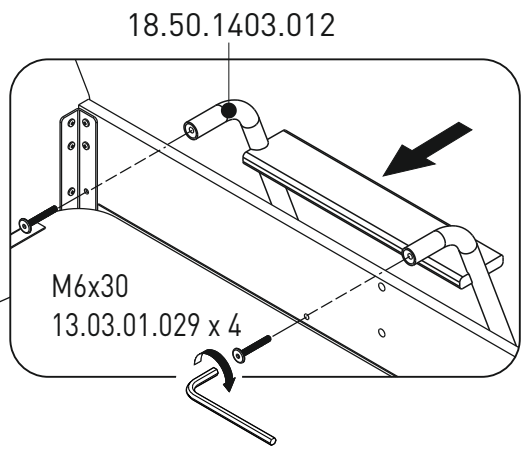
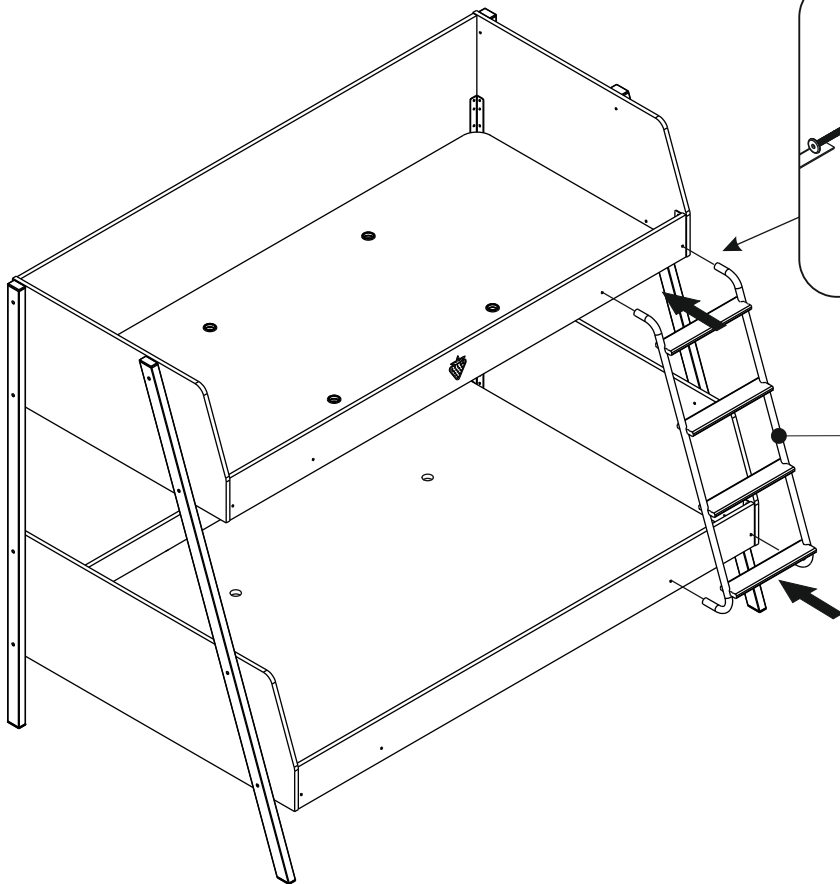

12a

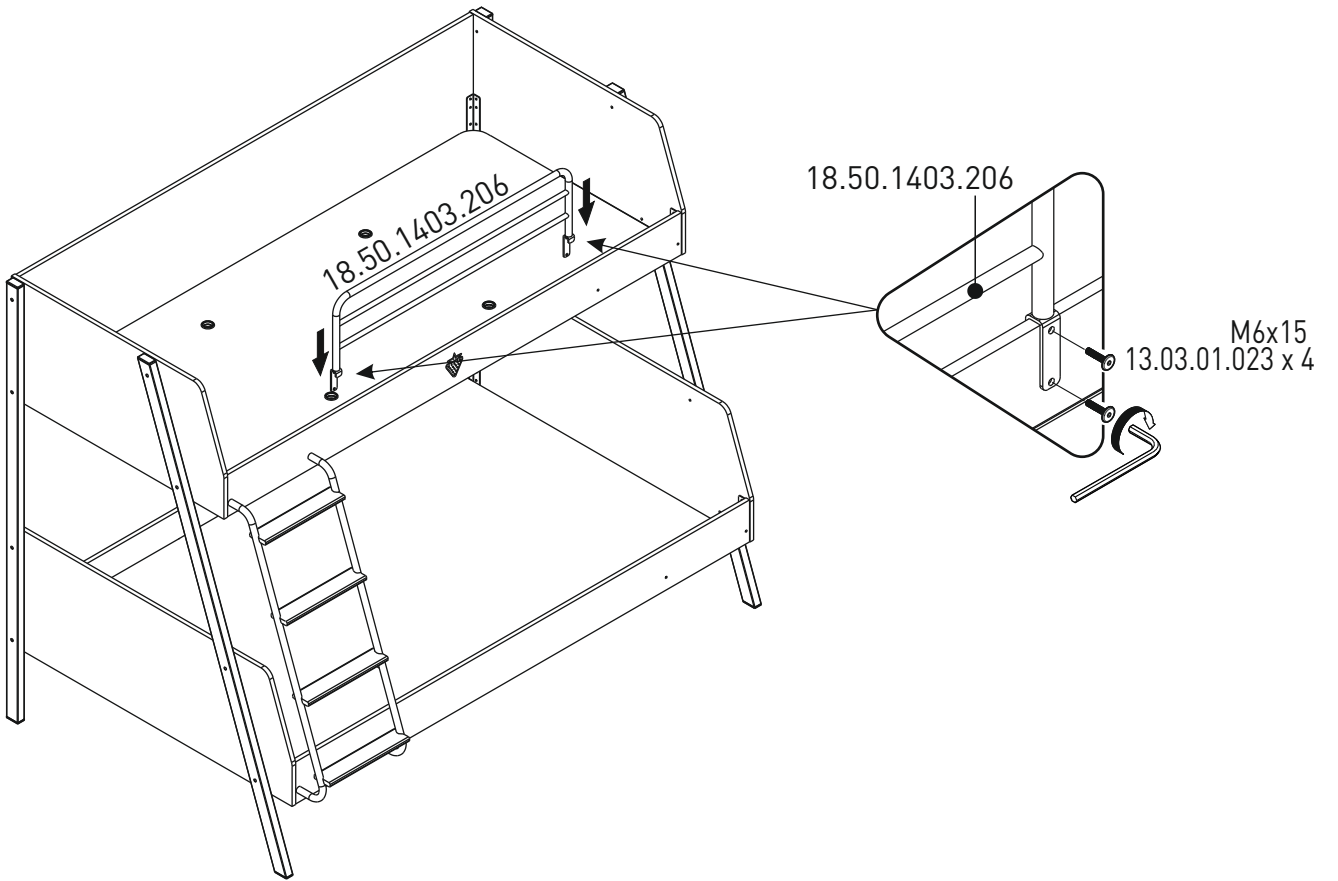

12b

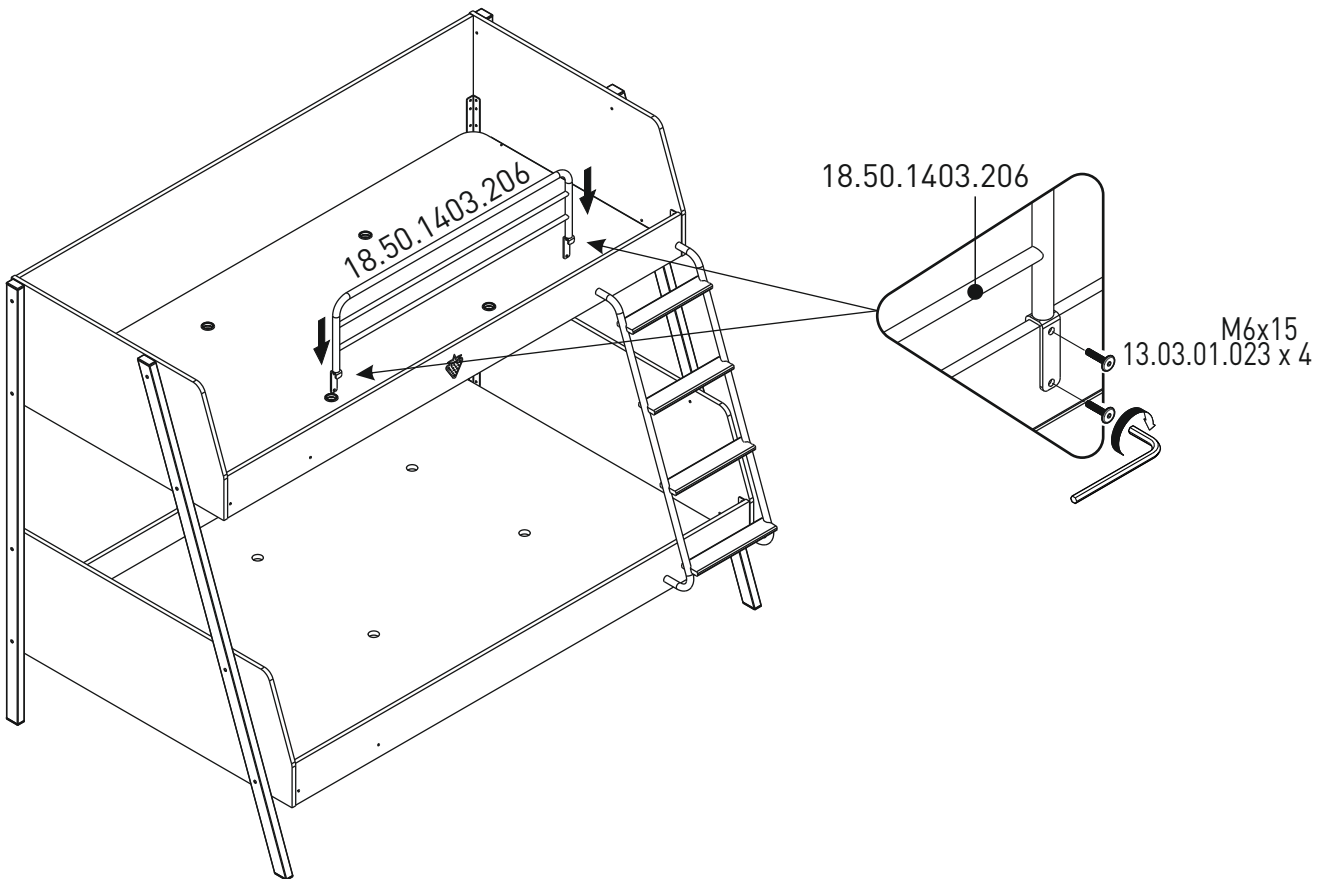

13a

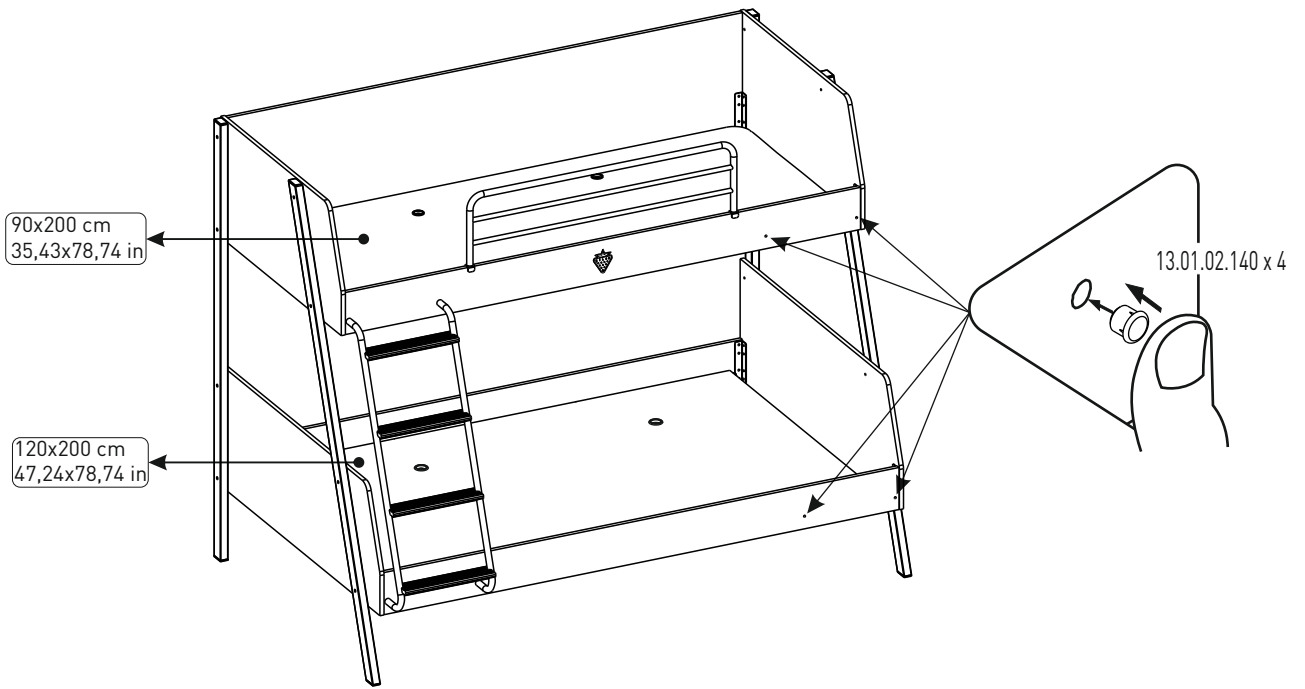

13b

