

20.40.1104.00

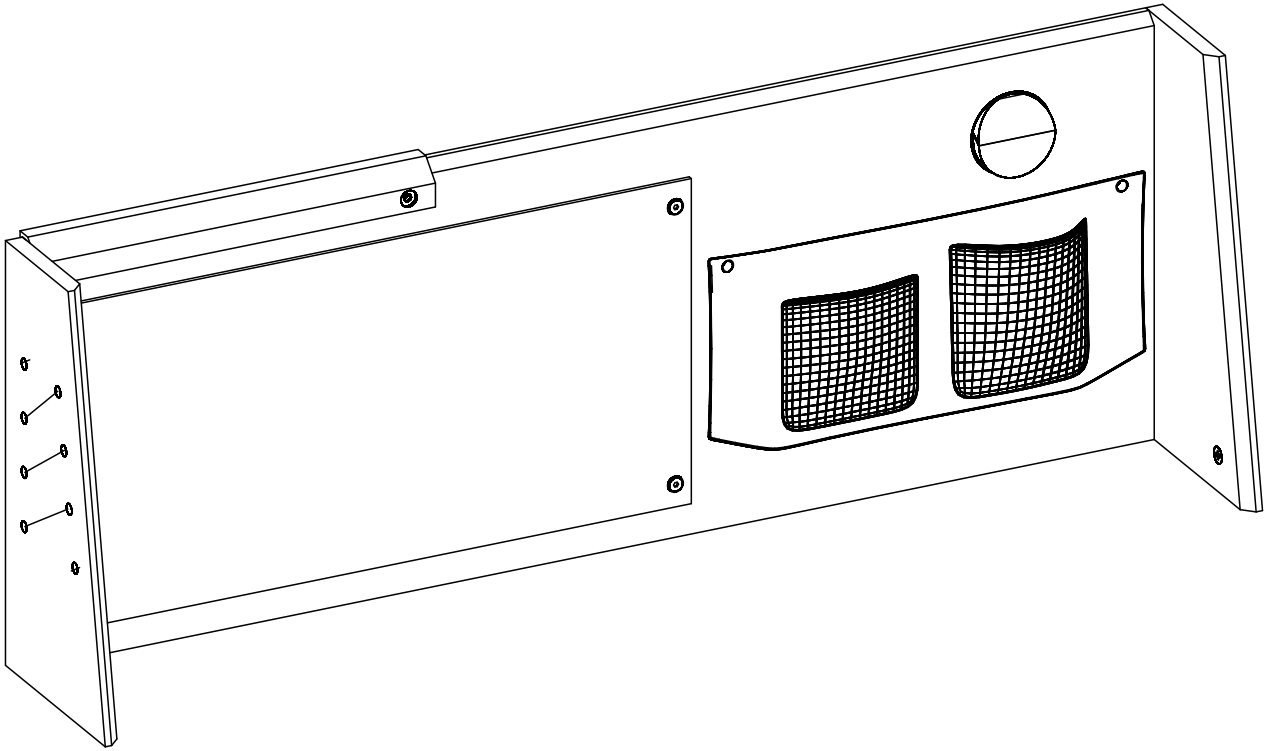

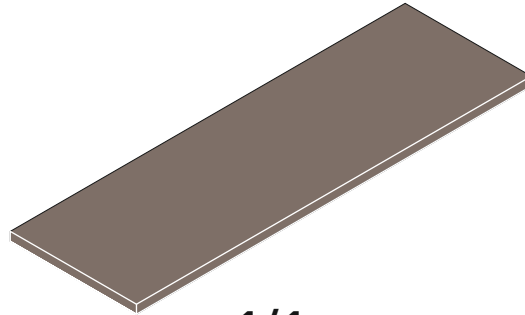

1 / 1

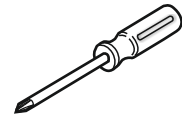
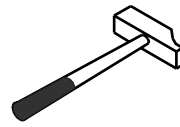
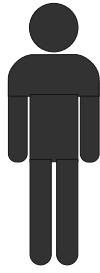
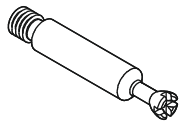

13.07.01.108 x 6

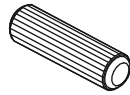

13.01.01.111 x 4



13.07.01.110 x 6



4X16
13.02.01.004 x 2



13.01.01.553 x 6

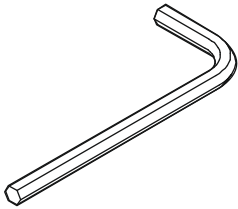

13.07.01.016 x 1

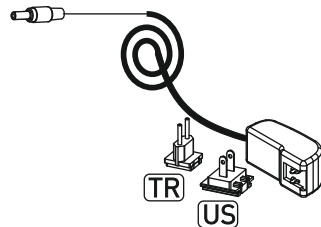

13.15.01.175 x 1

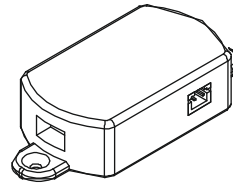

13.15.01.122 x 1



13.15.01.121 x 1



13.01.01.559 x 1

1 / 1

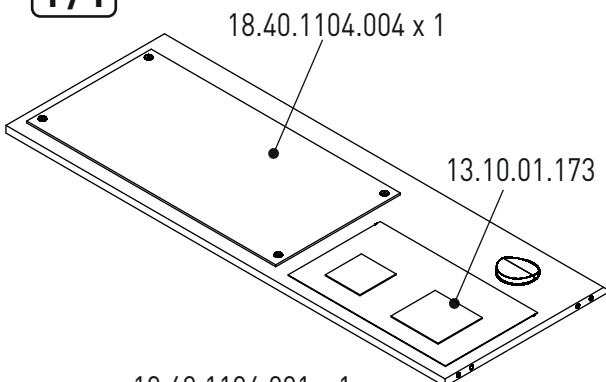

18.40.1104.001 x 1



13.15.01.117 x 1

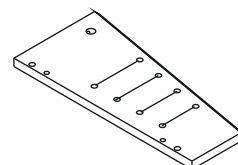

18.40.1104.002 x 1

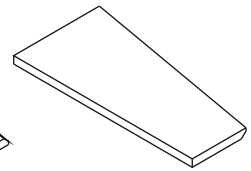

18.40.1104.003 x 1

1

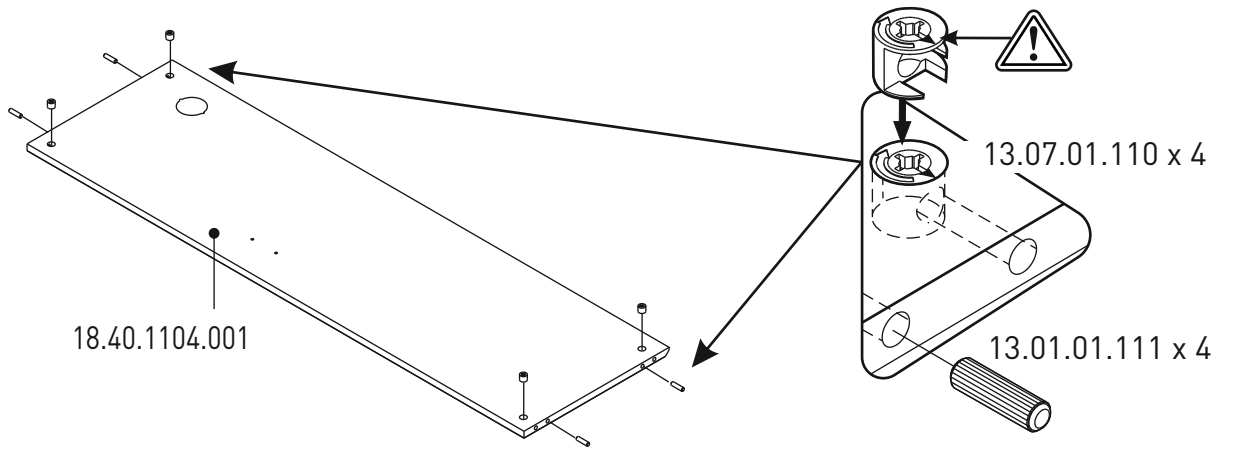

2

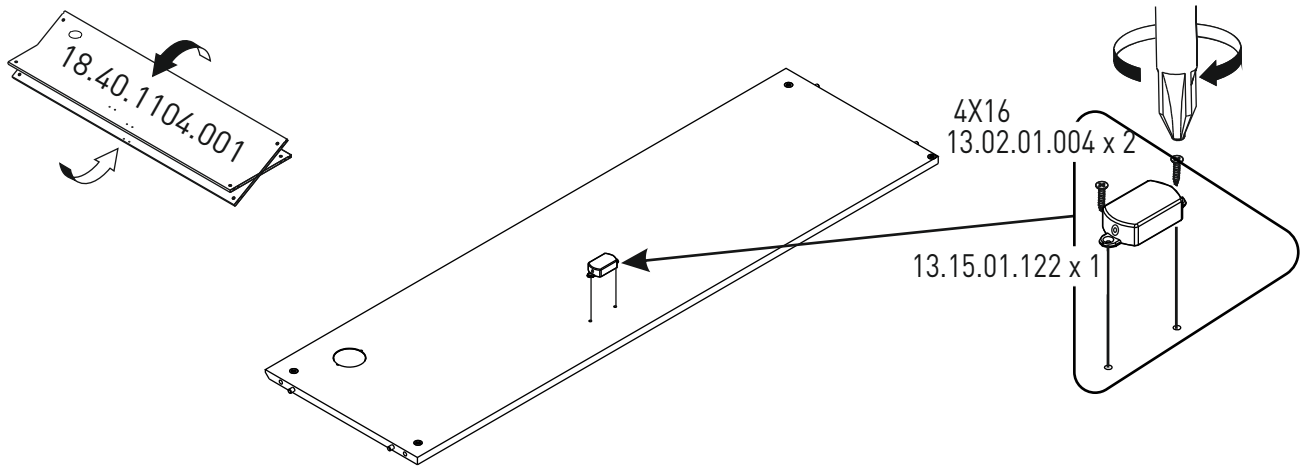

3

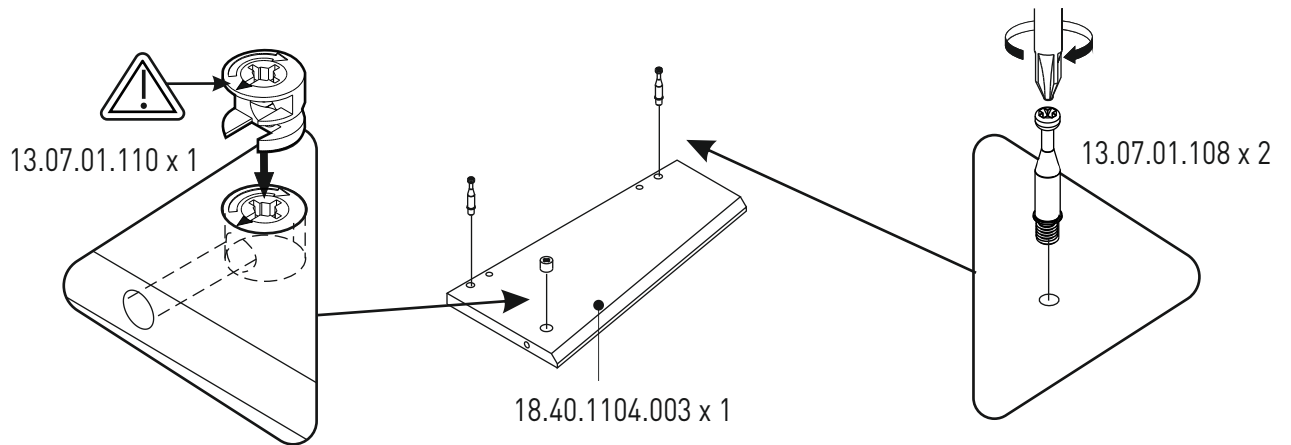

4

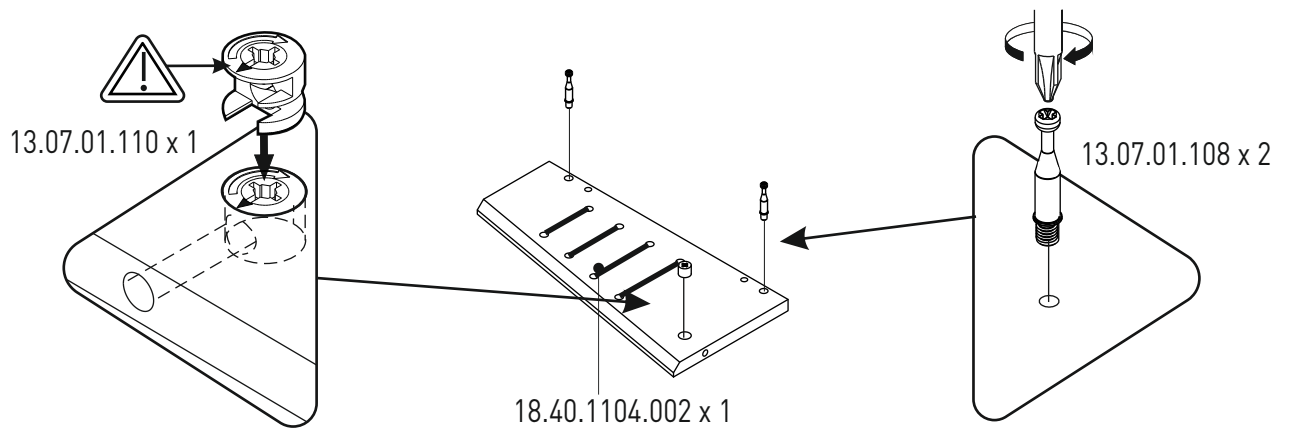

5

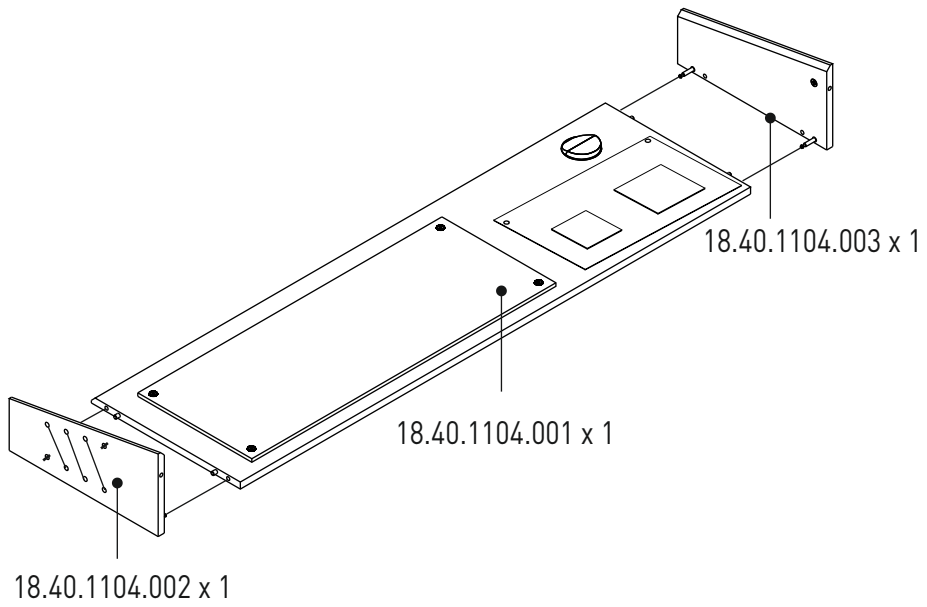

6

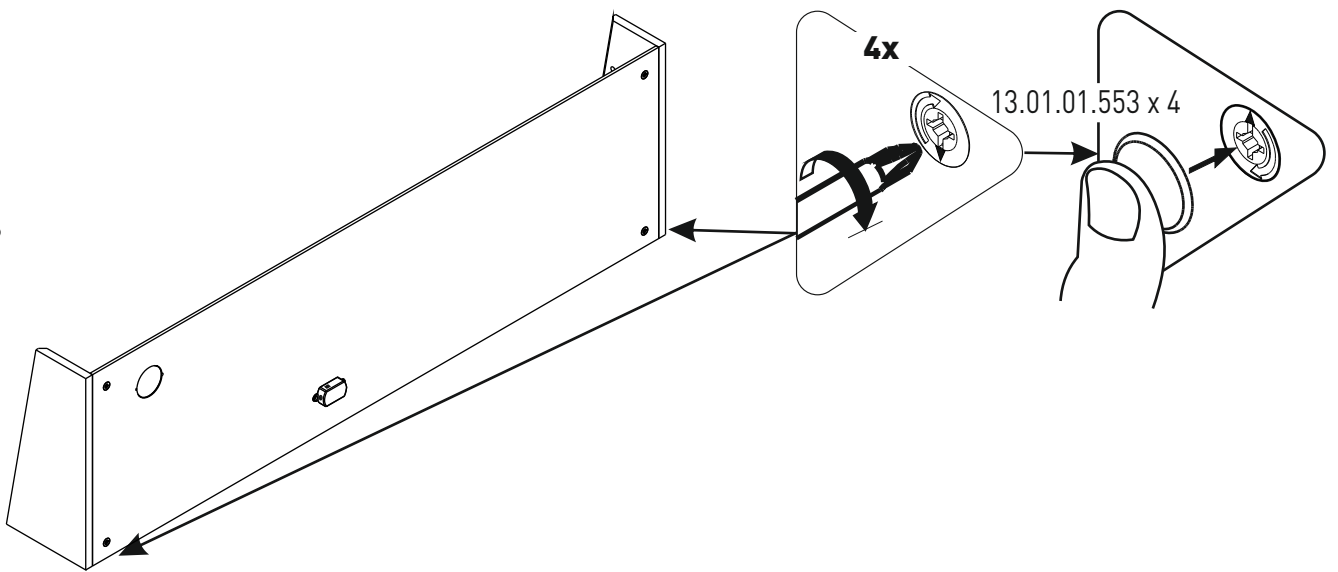

7

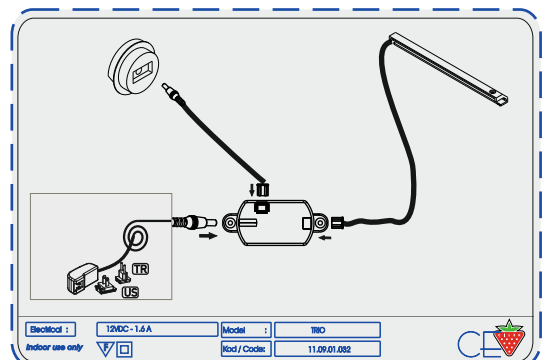
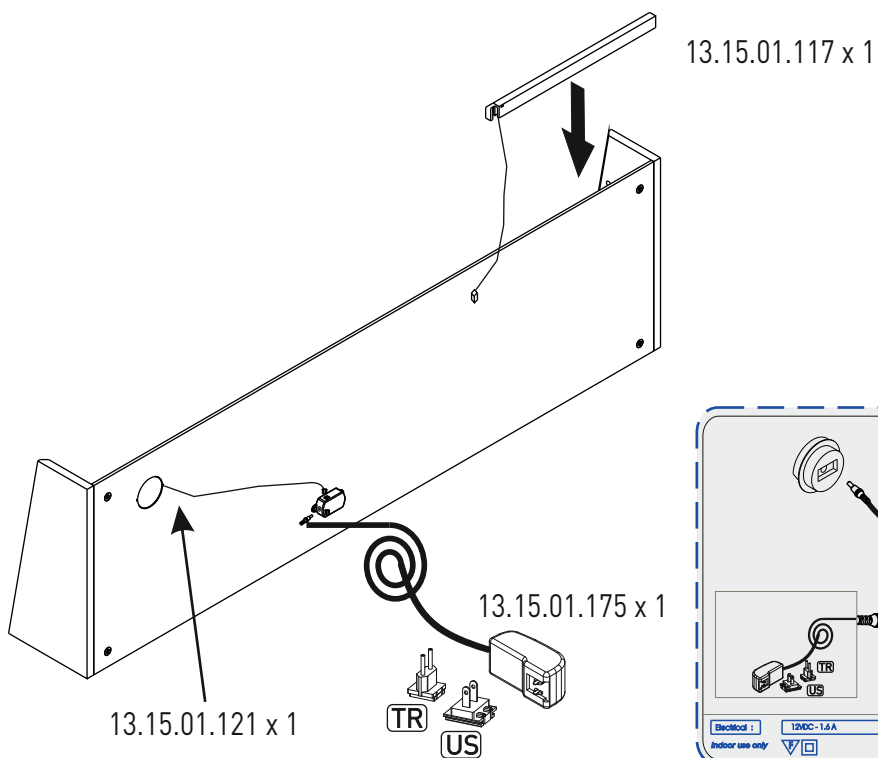

8

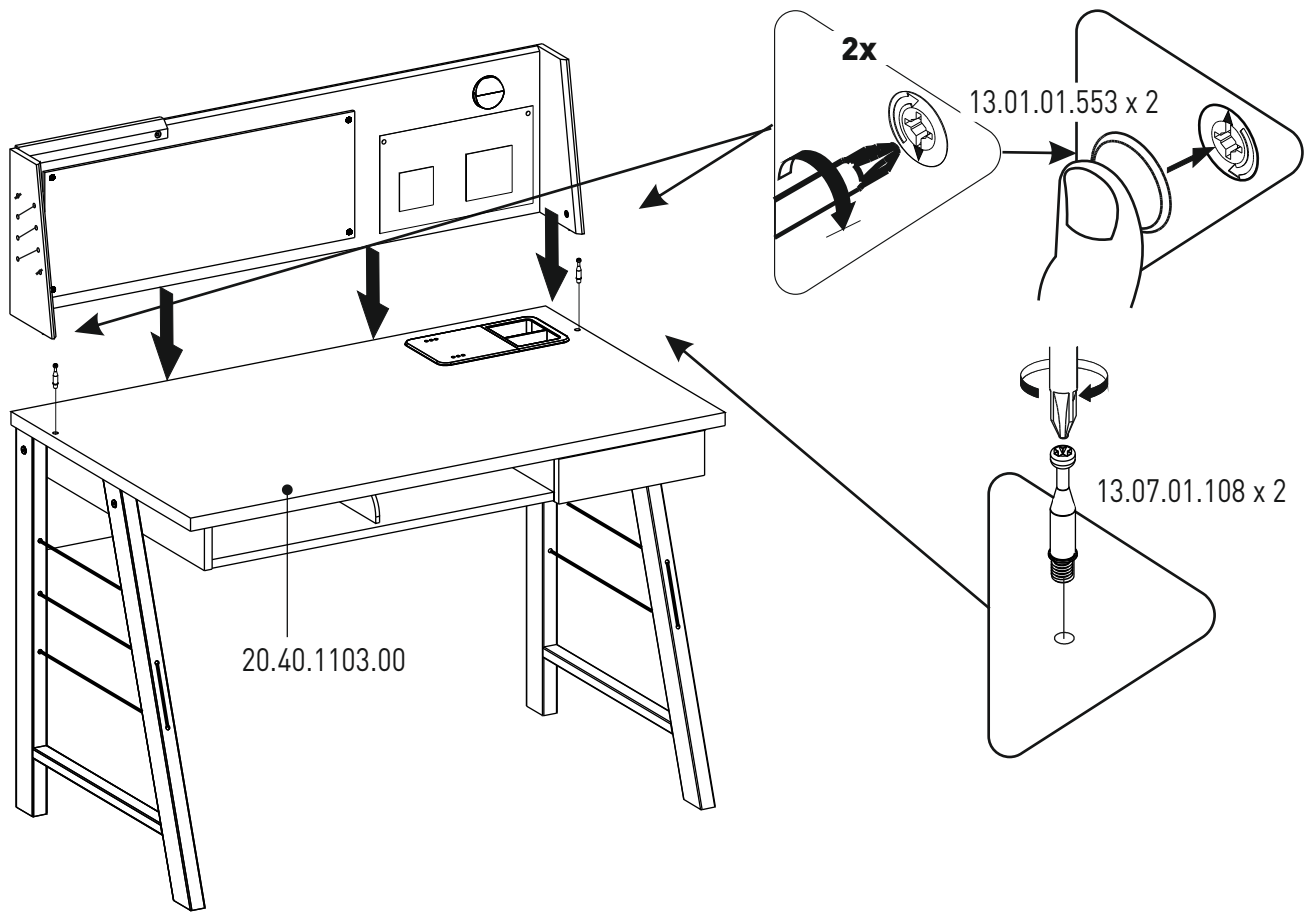

9

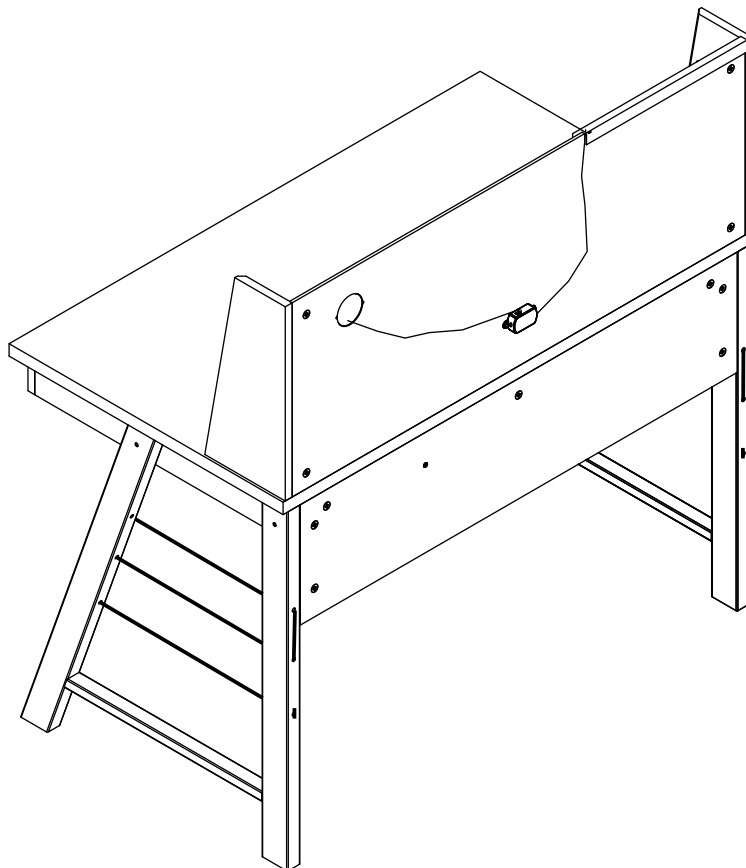

10

13.15.01.175 x 1

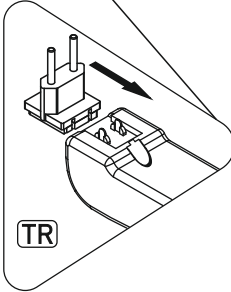

13.15.01.175

