

20.40.1401.00

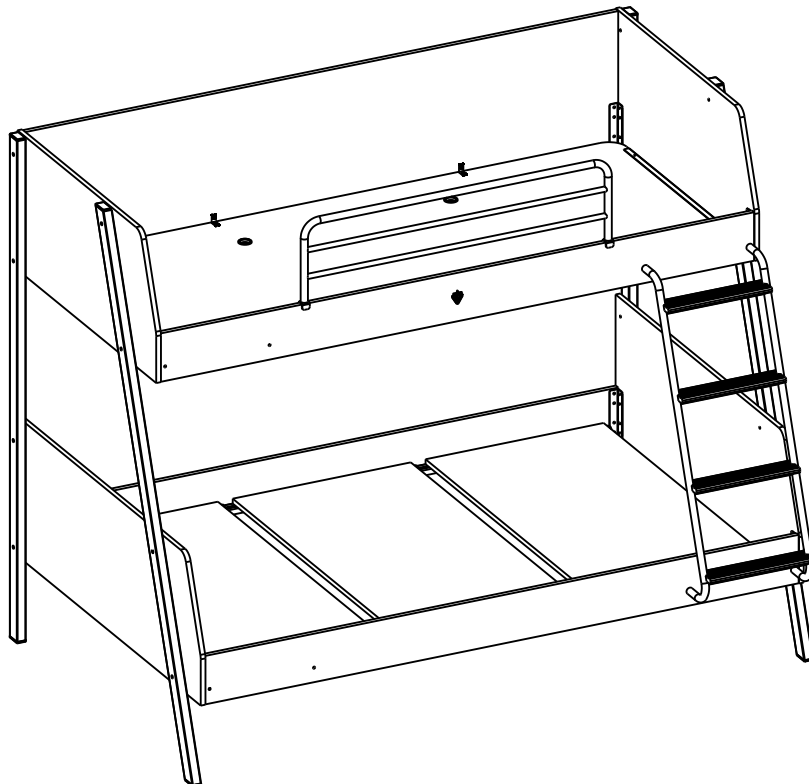

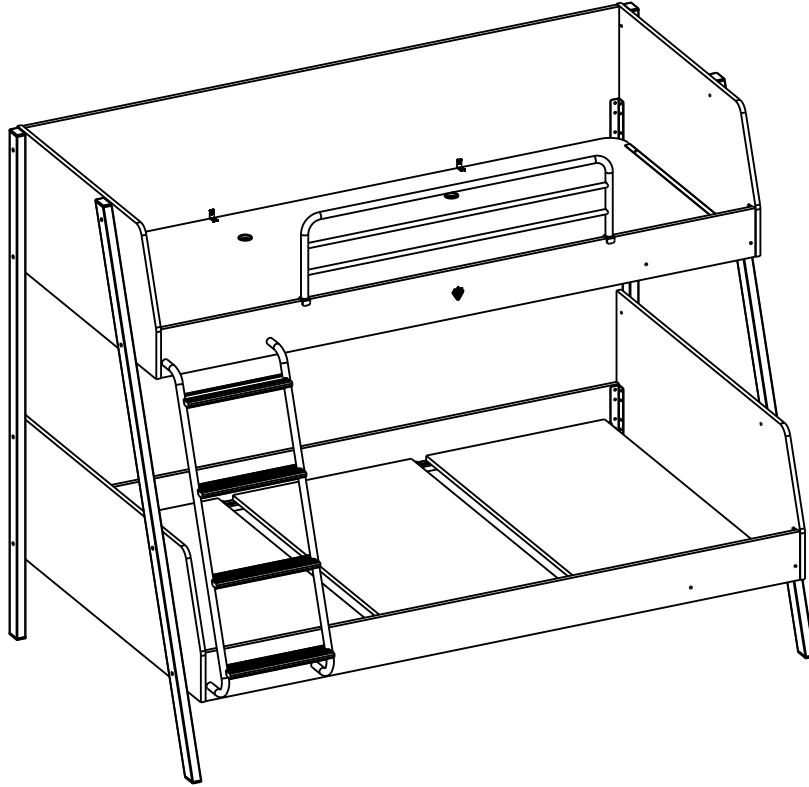

5 / 1

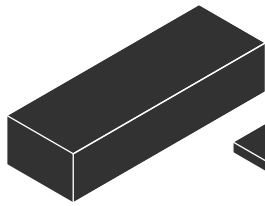
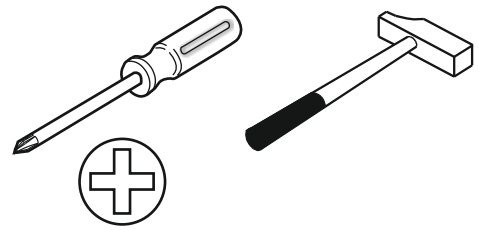
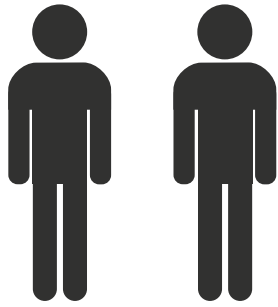
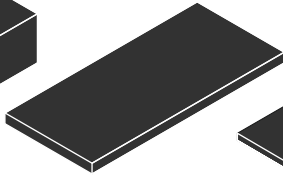

5 / 2

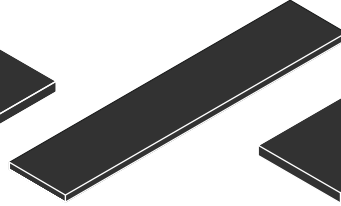

5 / 3

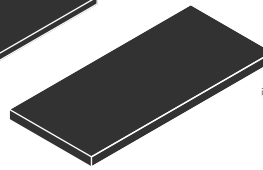

5 / 4

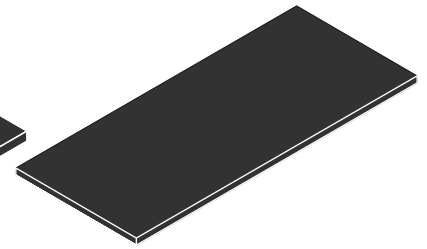

5 / 5



13.07.01.110 x 2

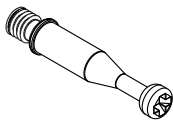

13.07.01.108 x 2

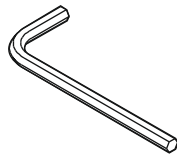

13.07.01.016 x 1



13.01.01.433 x 6

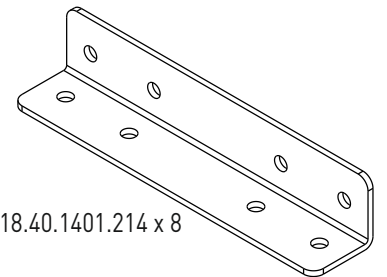

18.40.1401.214 x 8

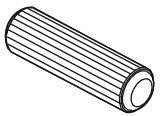

13.01.01.111 x 4



13.01.01.555 x 2



13.01.02.166 x 4

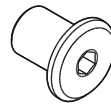

13.07.01.093 x 16



13.02.01.017 x 48

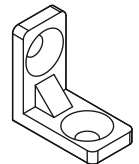

13.07.01.096 x 4

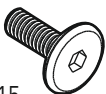

M6x15
13.03.01.023 x 4

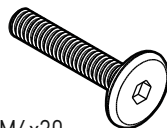

M6x30
13.03.01.029 x 4

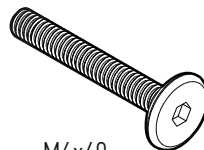

M6x40
13.03.01.035 x 16



3,5X16
13.02.01.001 x 4



M6X13
13.03.01.021 x 62



M6X15
13.03.01.024 x 4

5 / 1

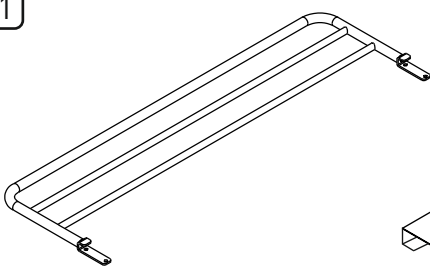

18.40.1401.206 x 1

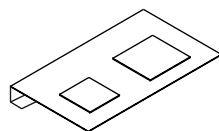

13.10.01.174 x 1

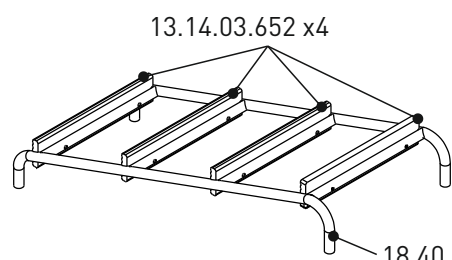

18.40.1401.012 x 1

13.14.03.652 x 4

18.40.1401.204

5/2

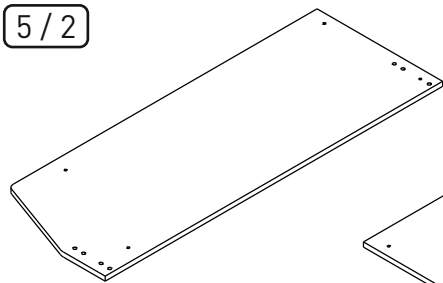

18.40.1401.001 x1

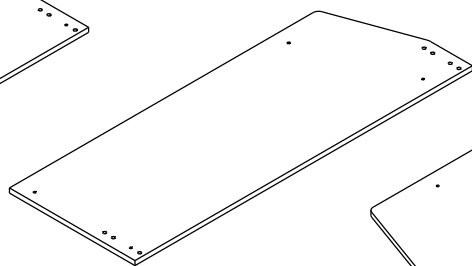

18.40.1401.002 x1

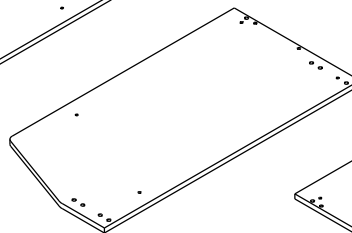

18.40.1401.006 x1

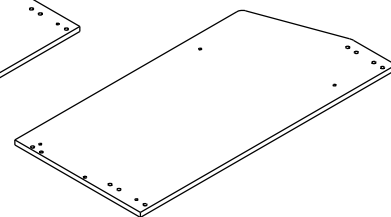

18.40.1401.007 x1

5/3

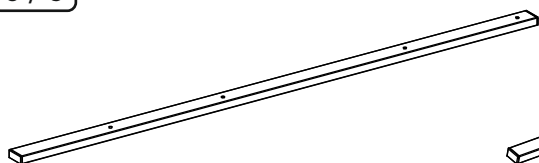

18.40.1401.201 x2

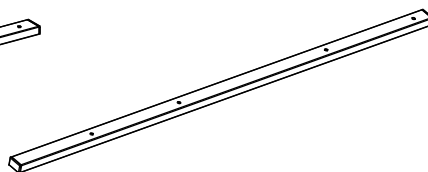

18.40.1401.202 x2

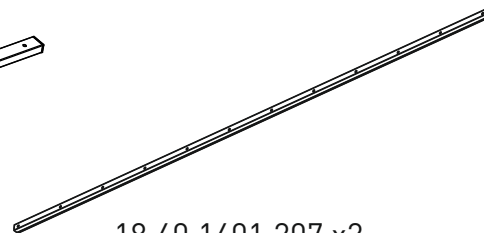

18.40.1401.207 x2

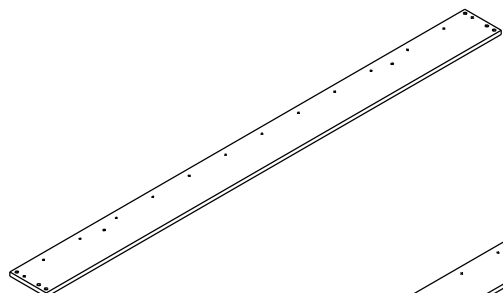

18.40.1401.004 x1

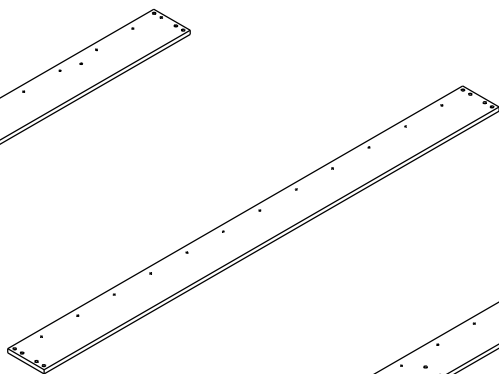

18.40.1401.003 x1

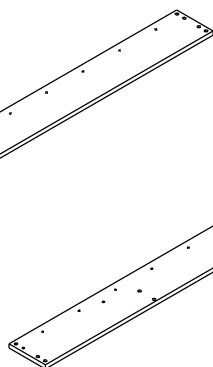

18.40.1401.005 x1

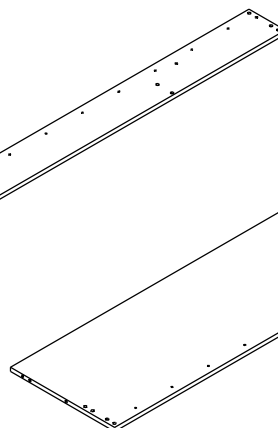

18.40.1401.008 x1

5/4

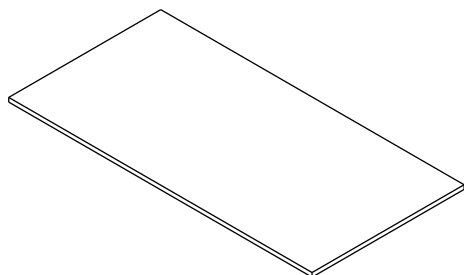

18.40.1401.009 x3

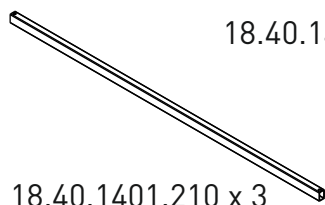

18.40.1401.210 x3

5/5

18.40.1401.207 x2

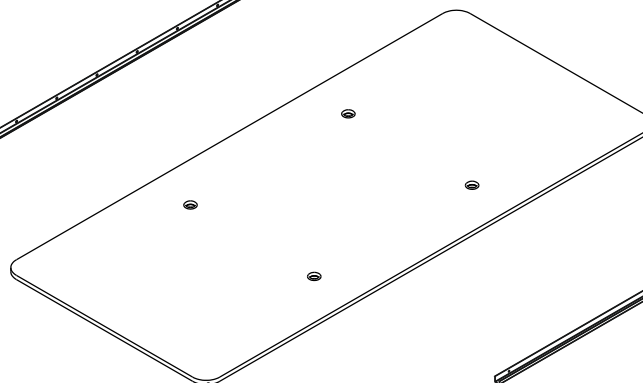
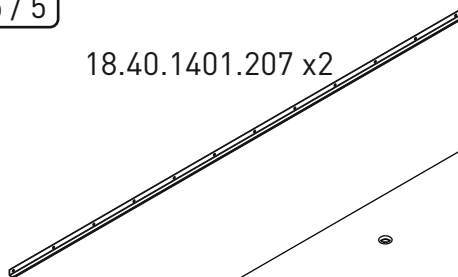

18.40.1401.010 x1



18.40.1401.208 x2

1

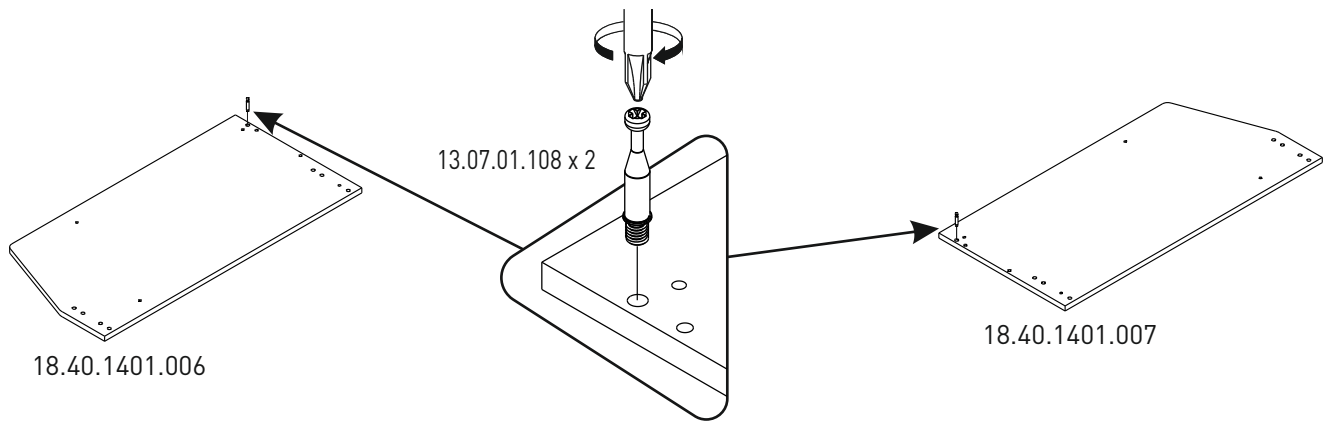

2

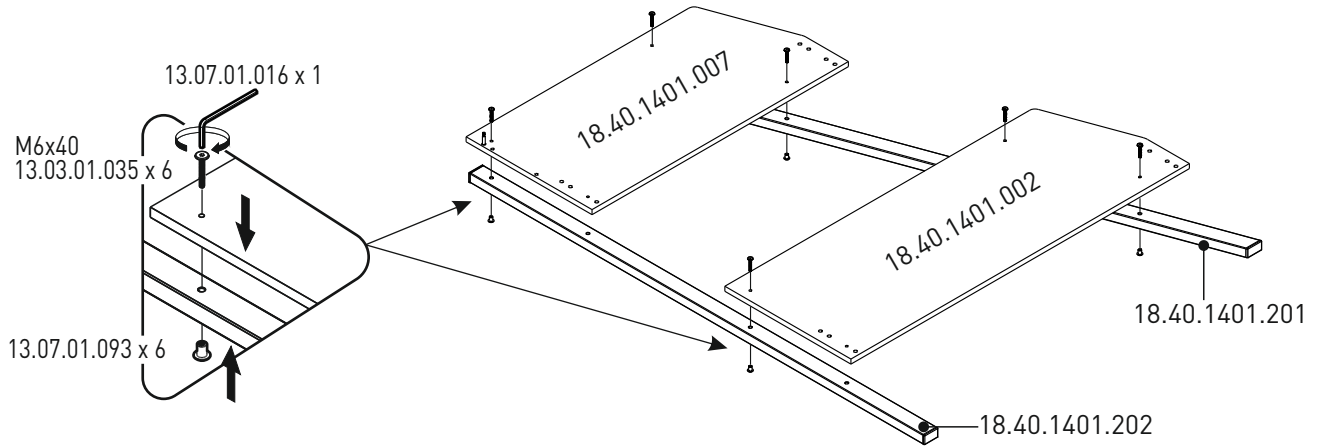

3

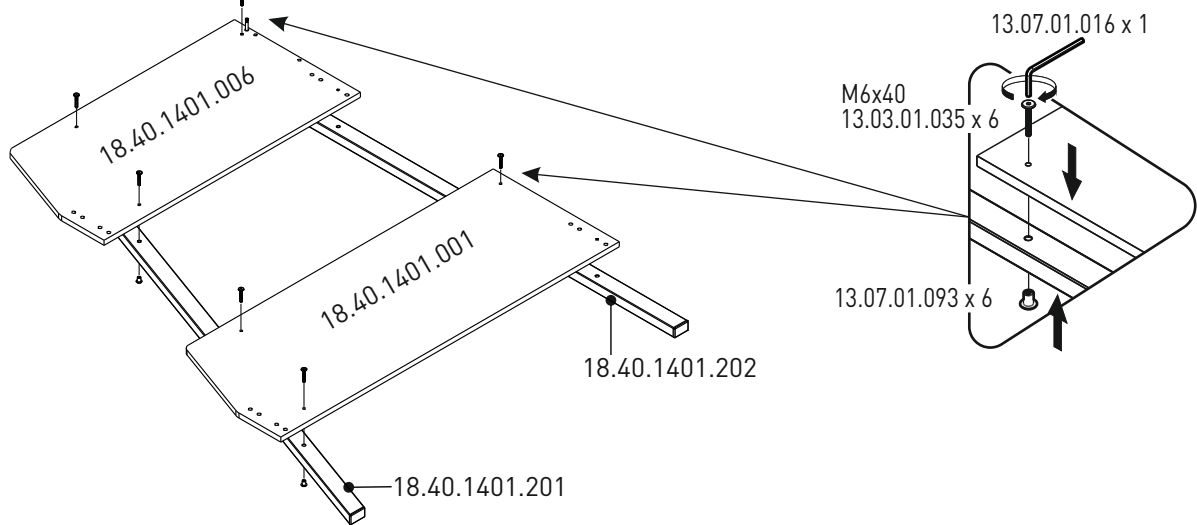

4

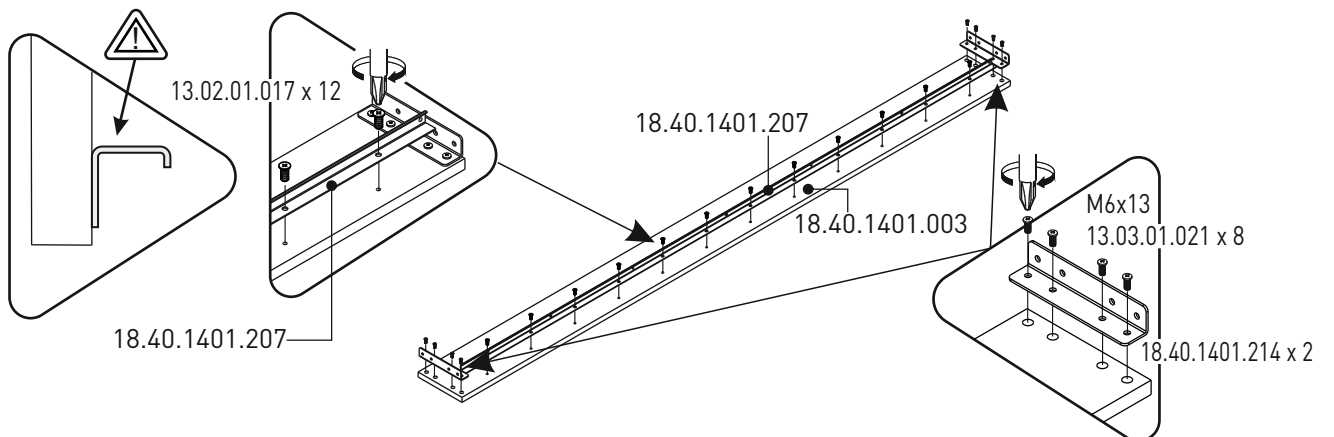

5

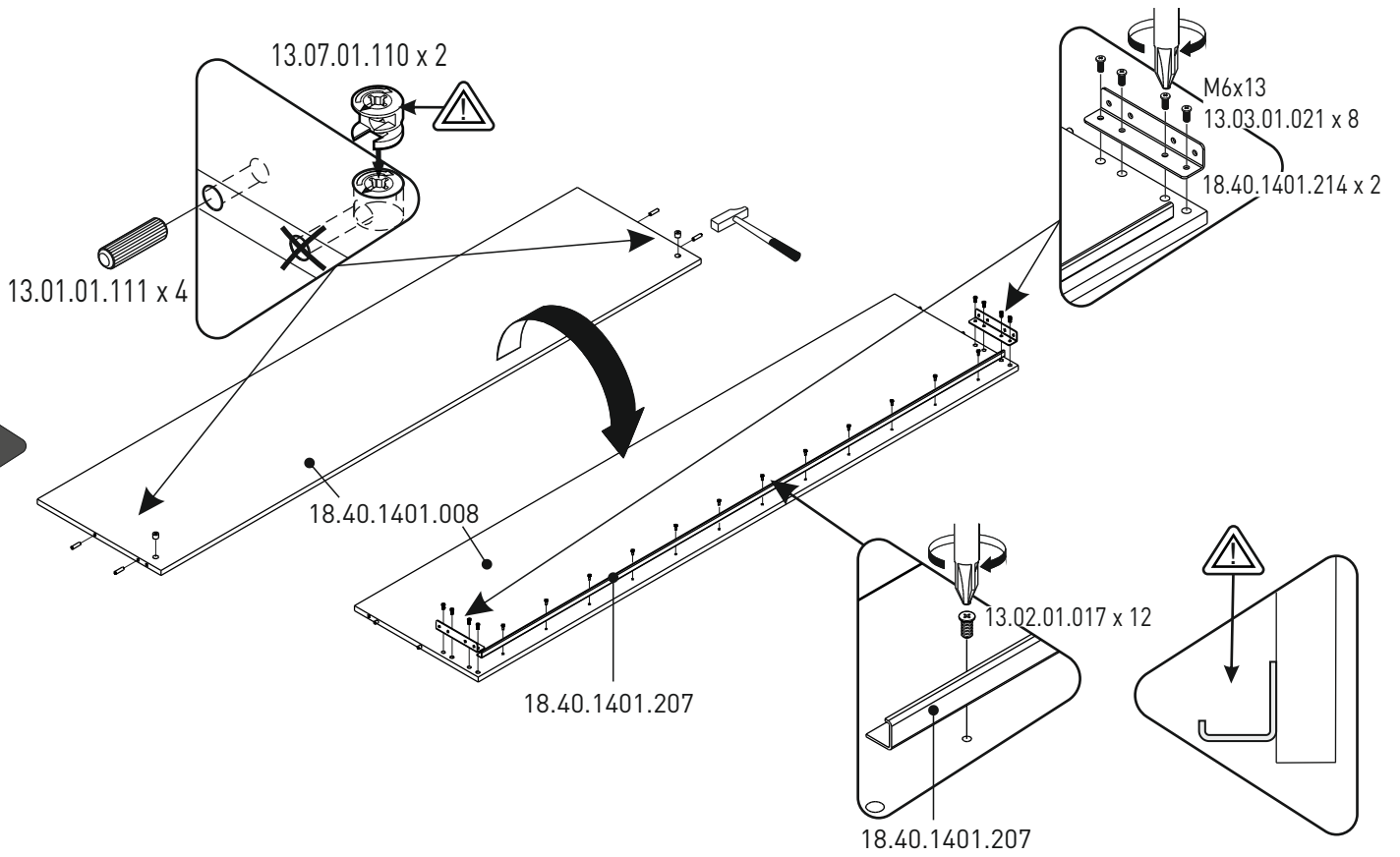

6

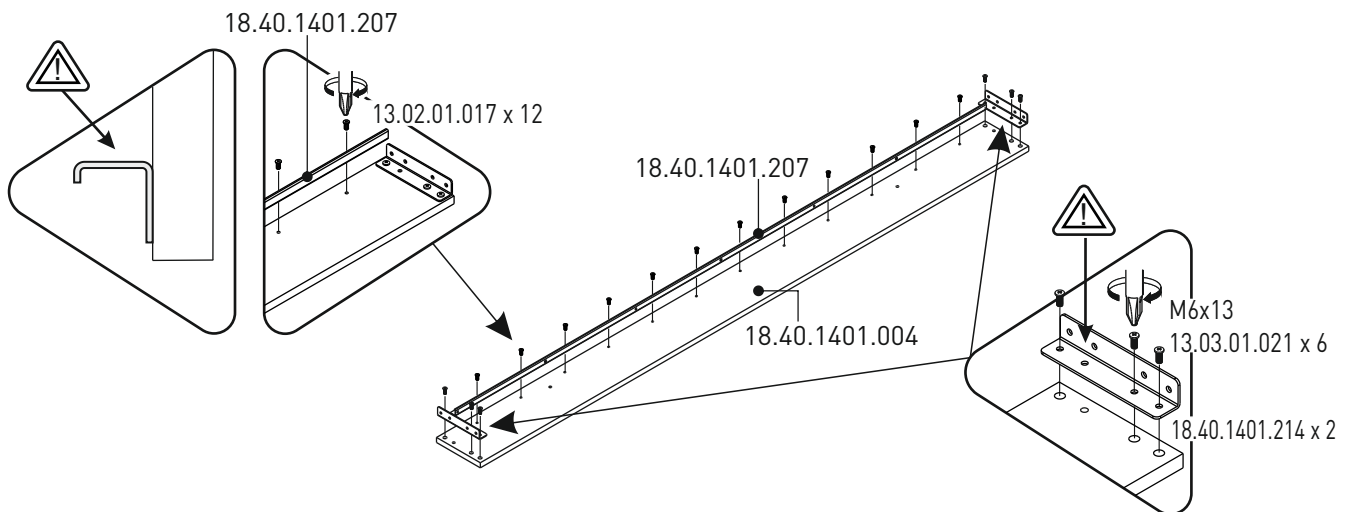

7

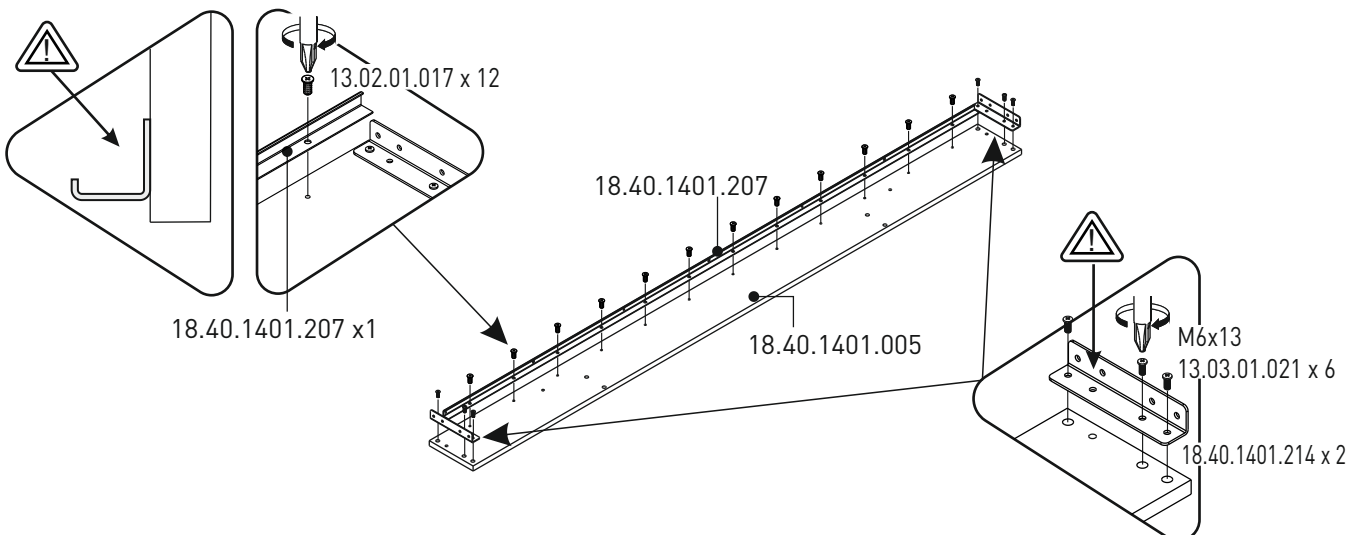

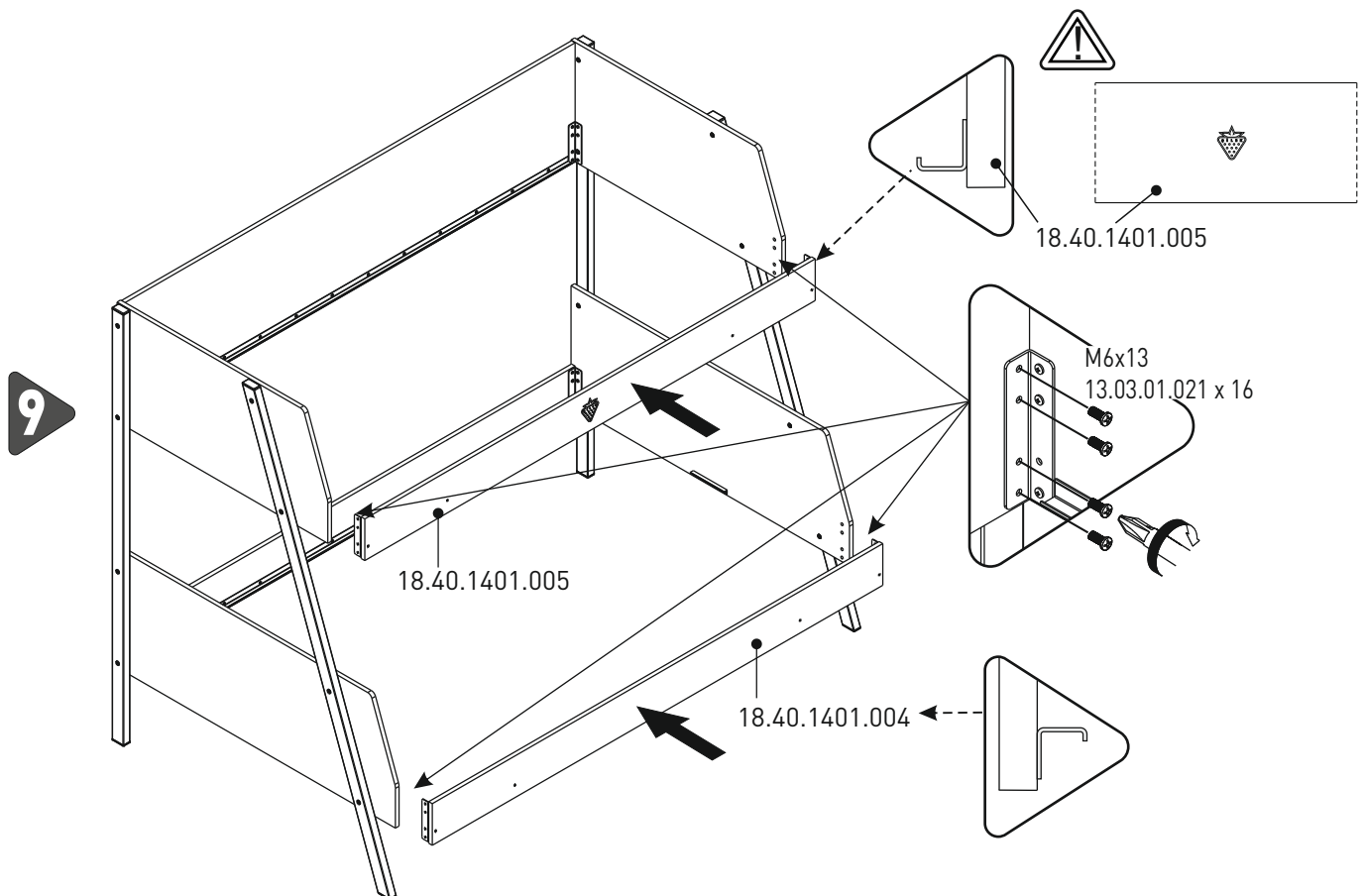
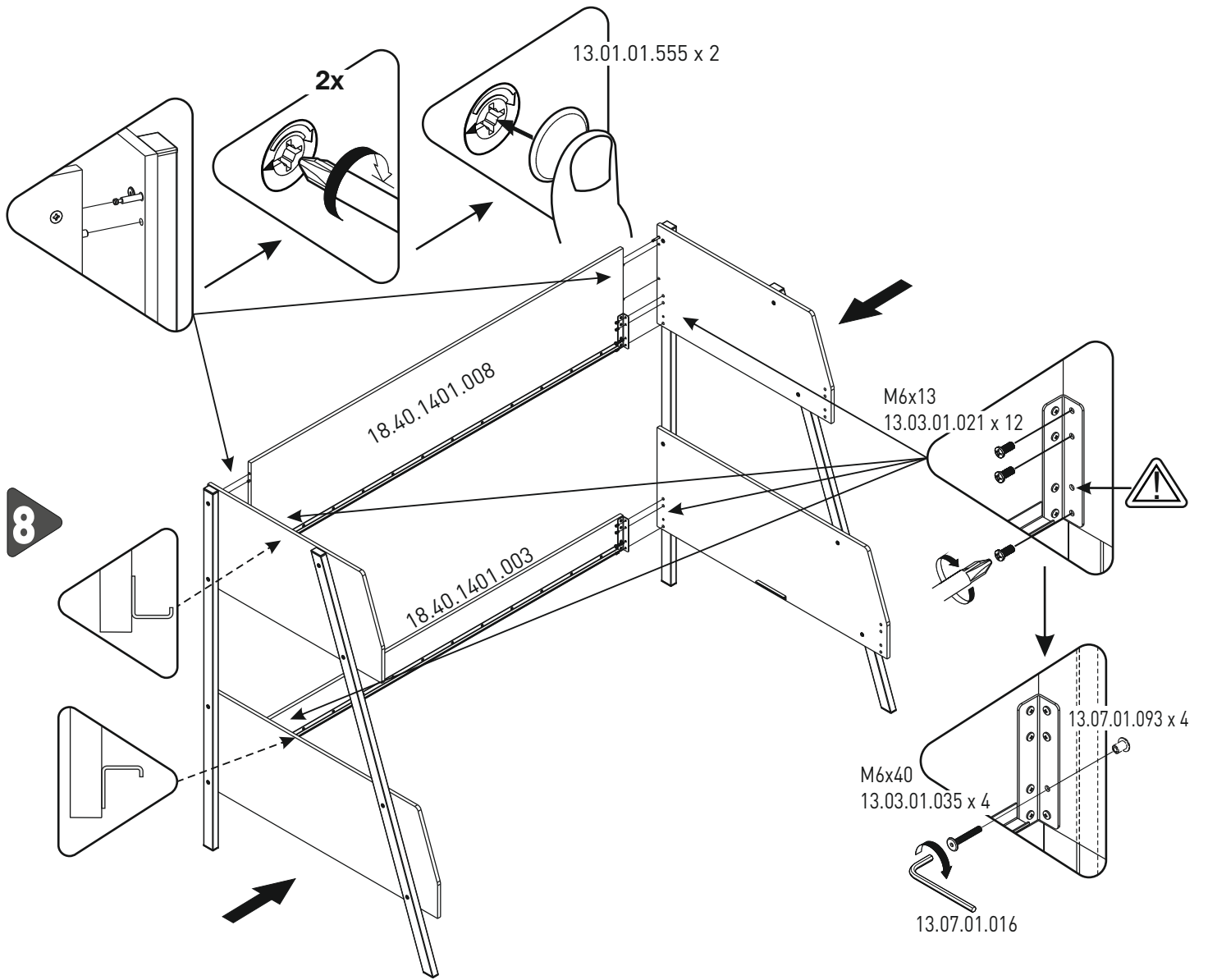

10

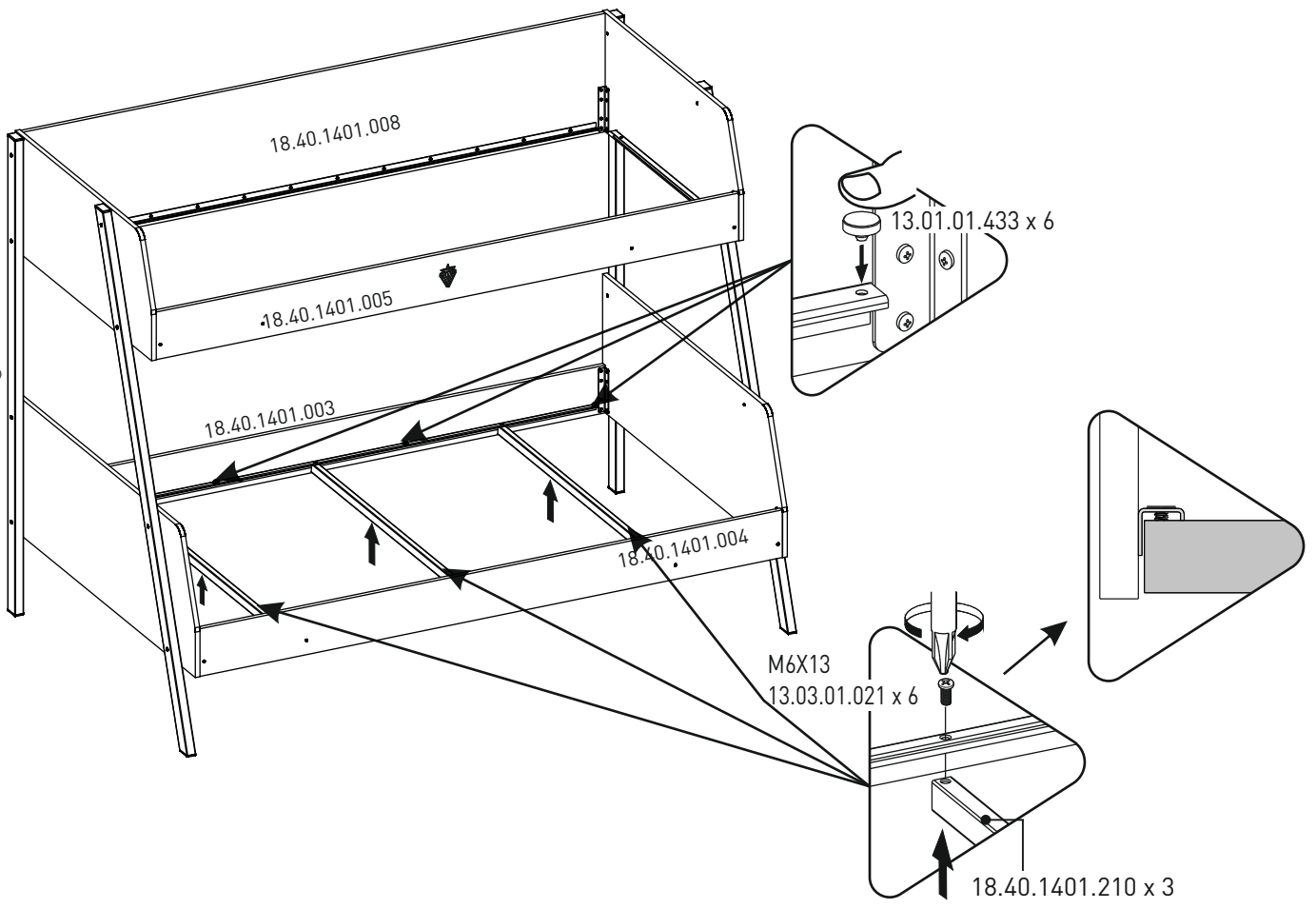

11

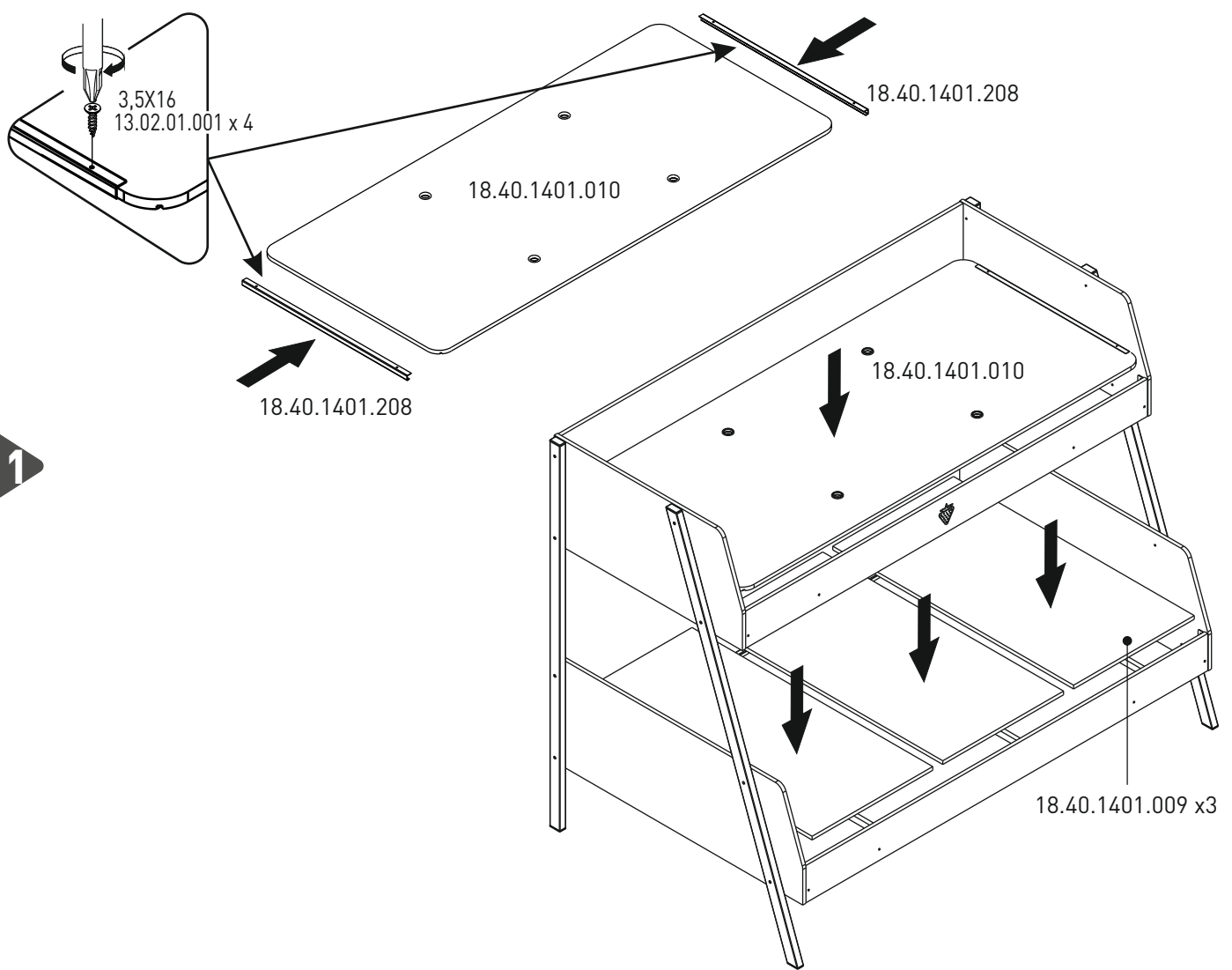

12a

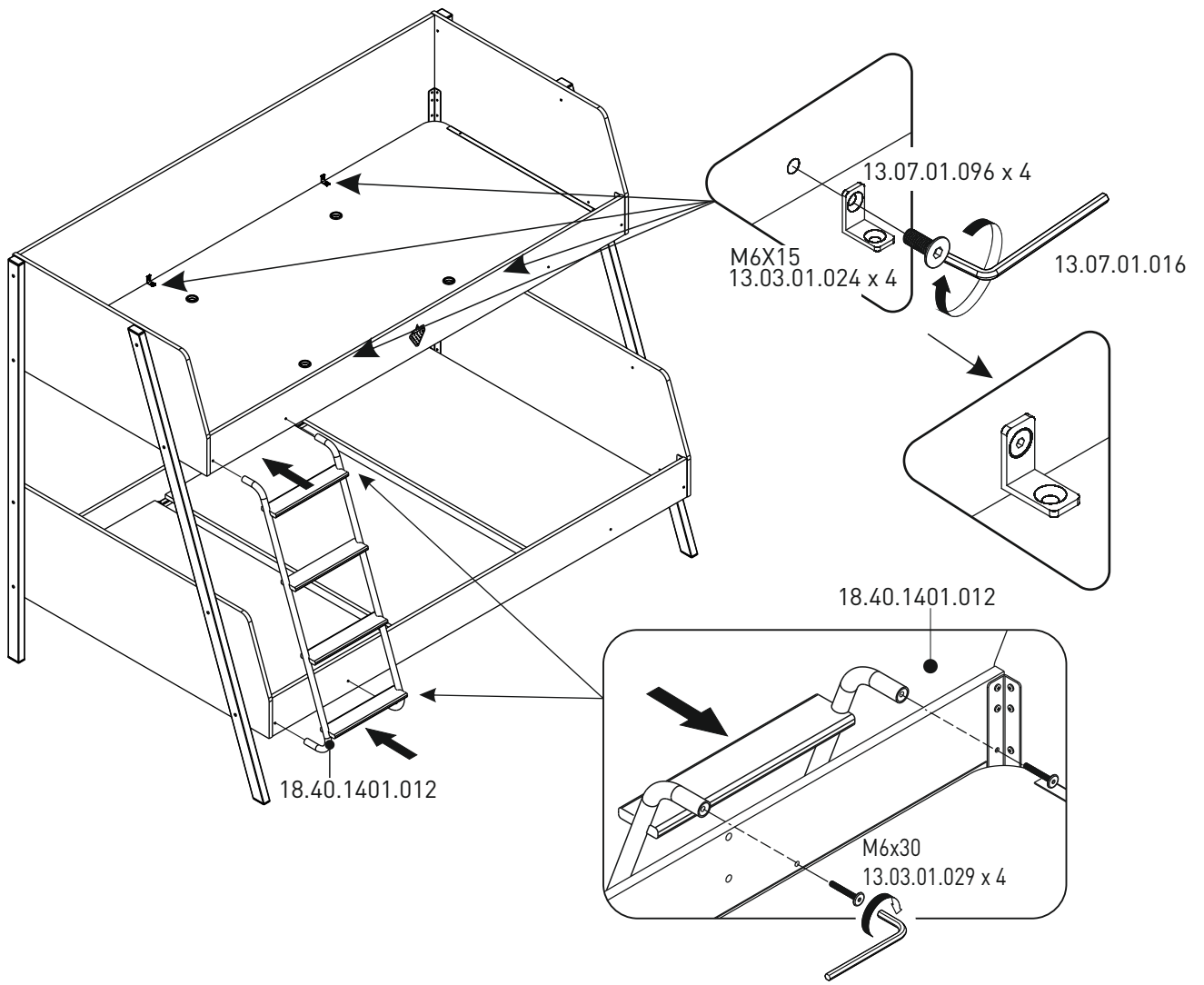

12b

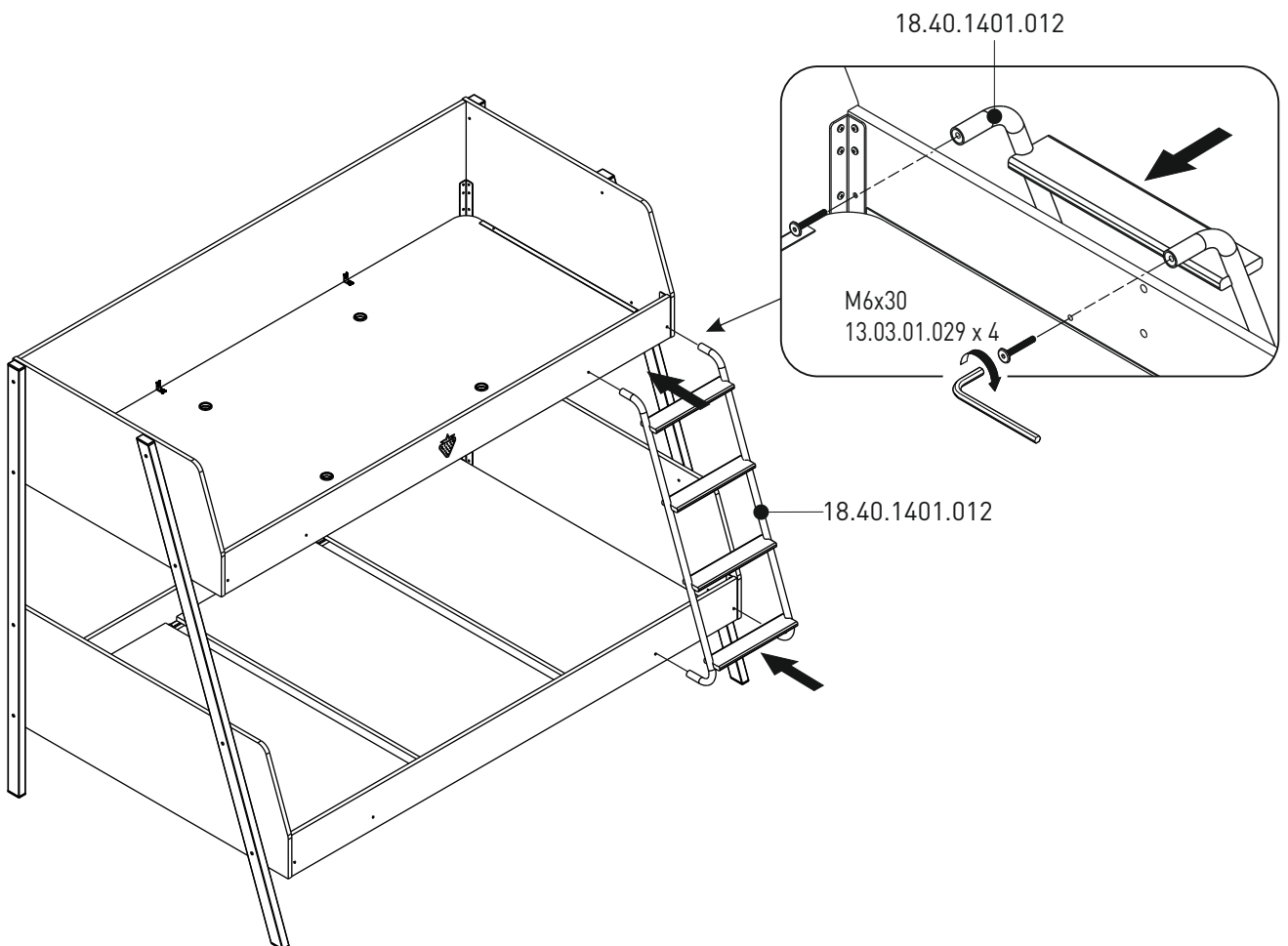

13a

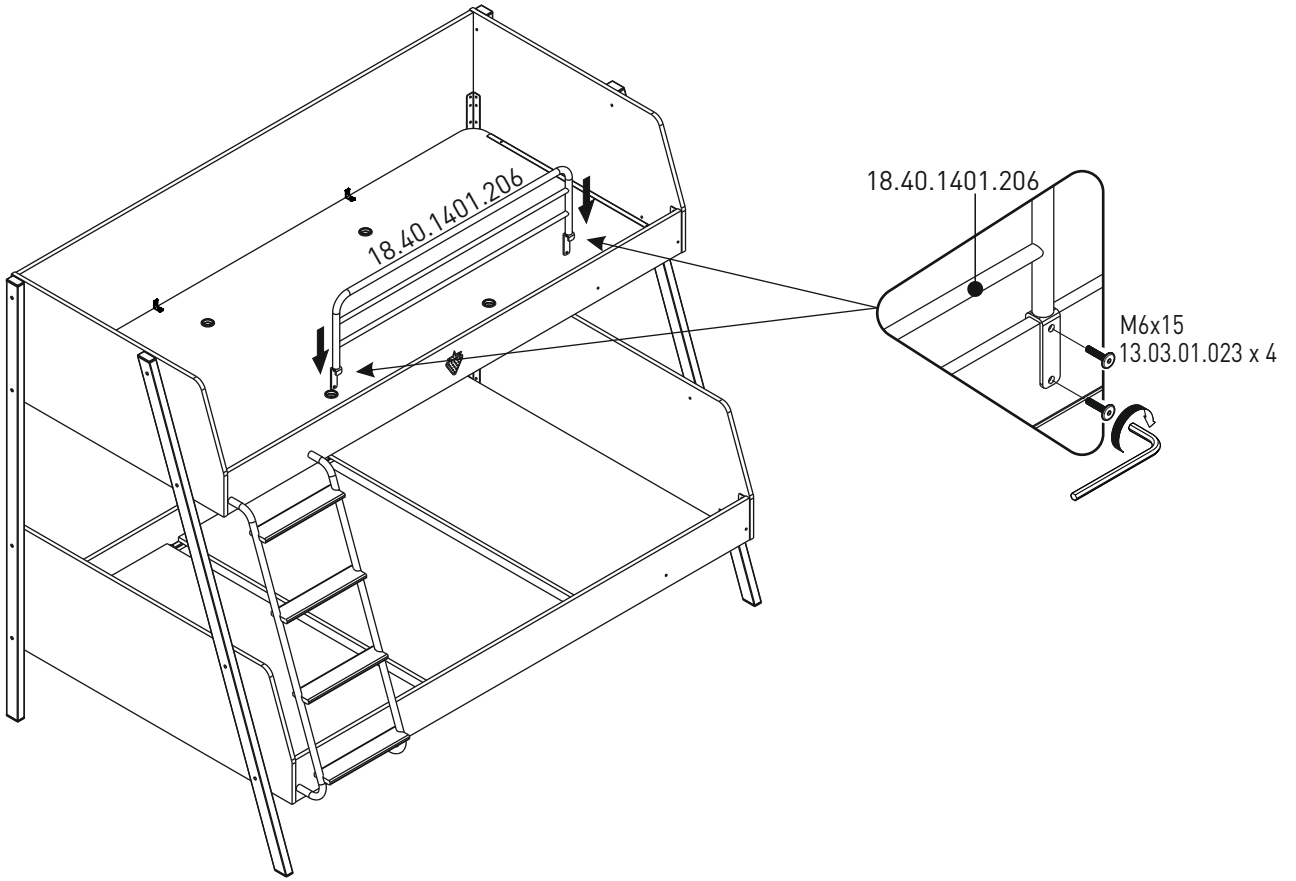

13b

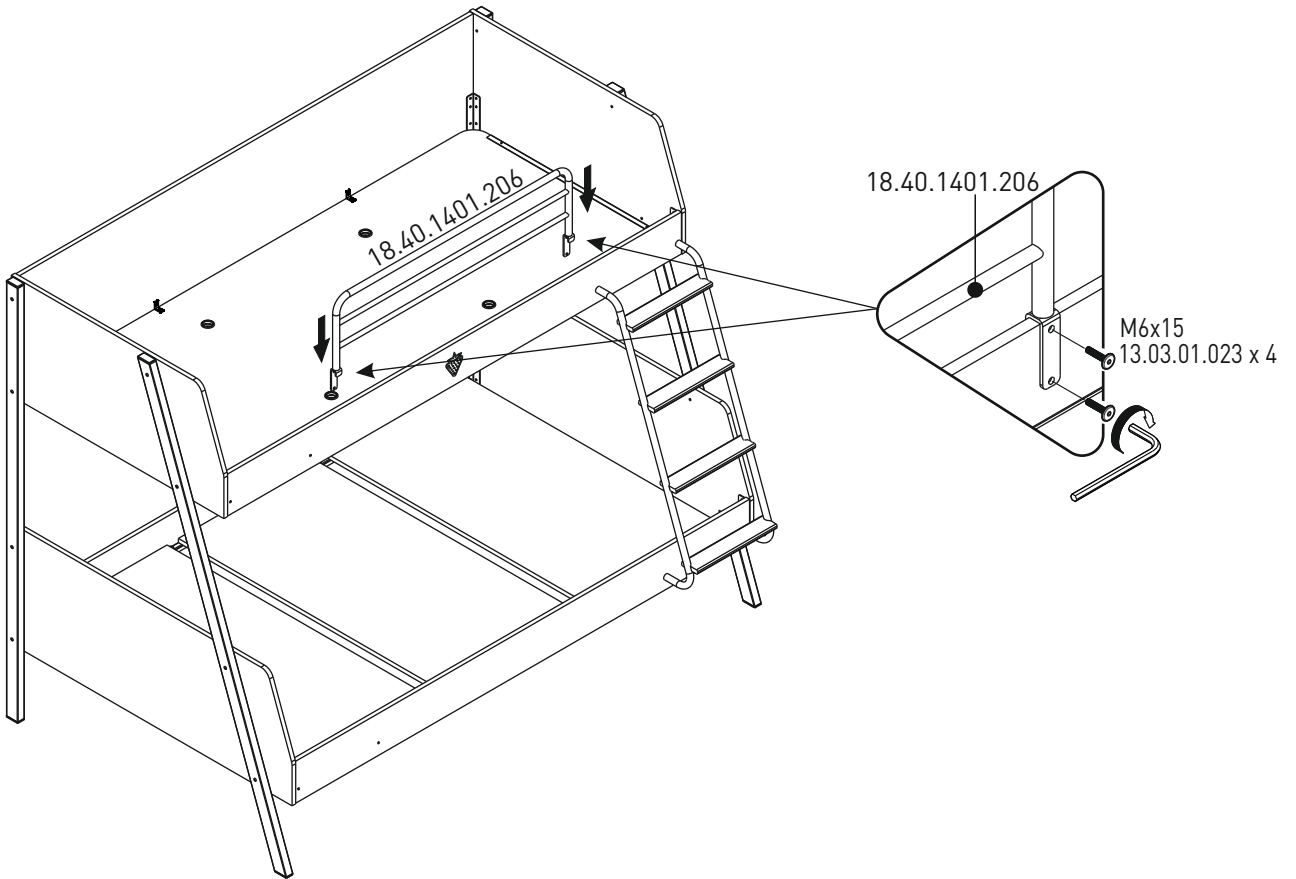

14a

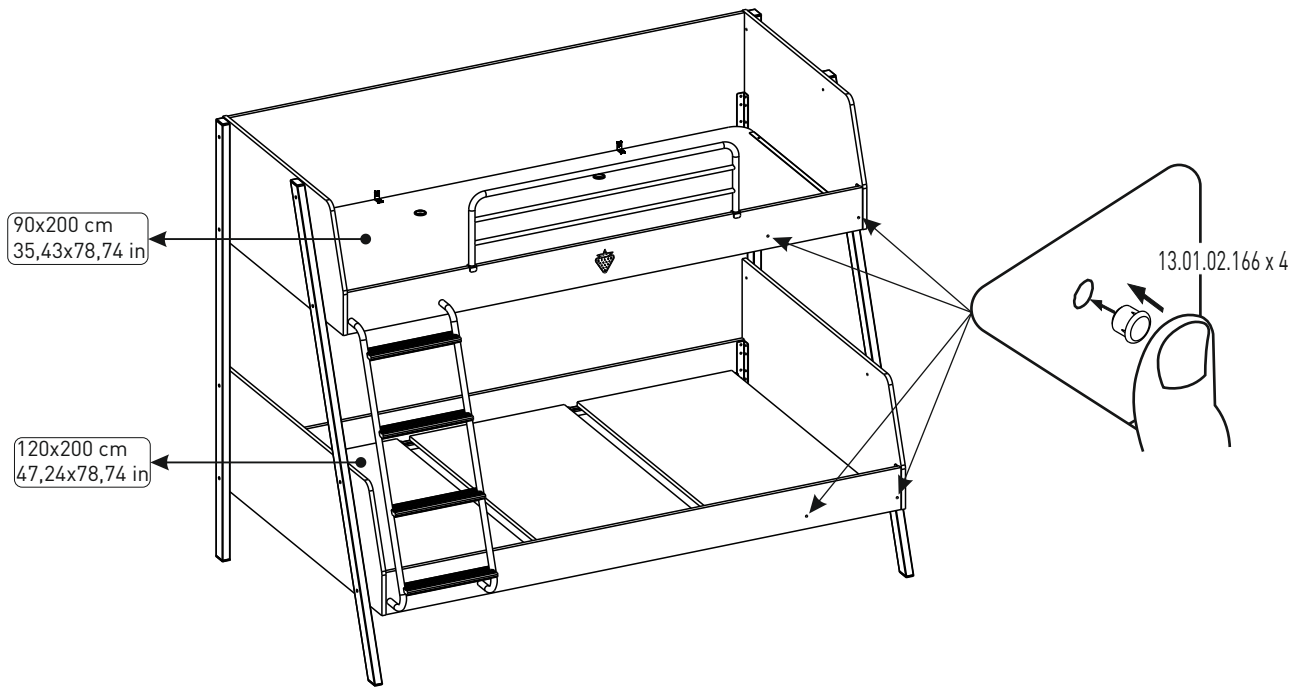

14b

