

20.58.1303.00

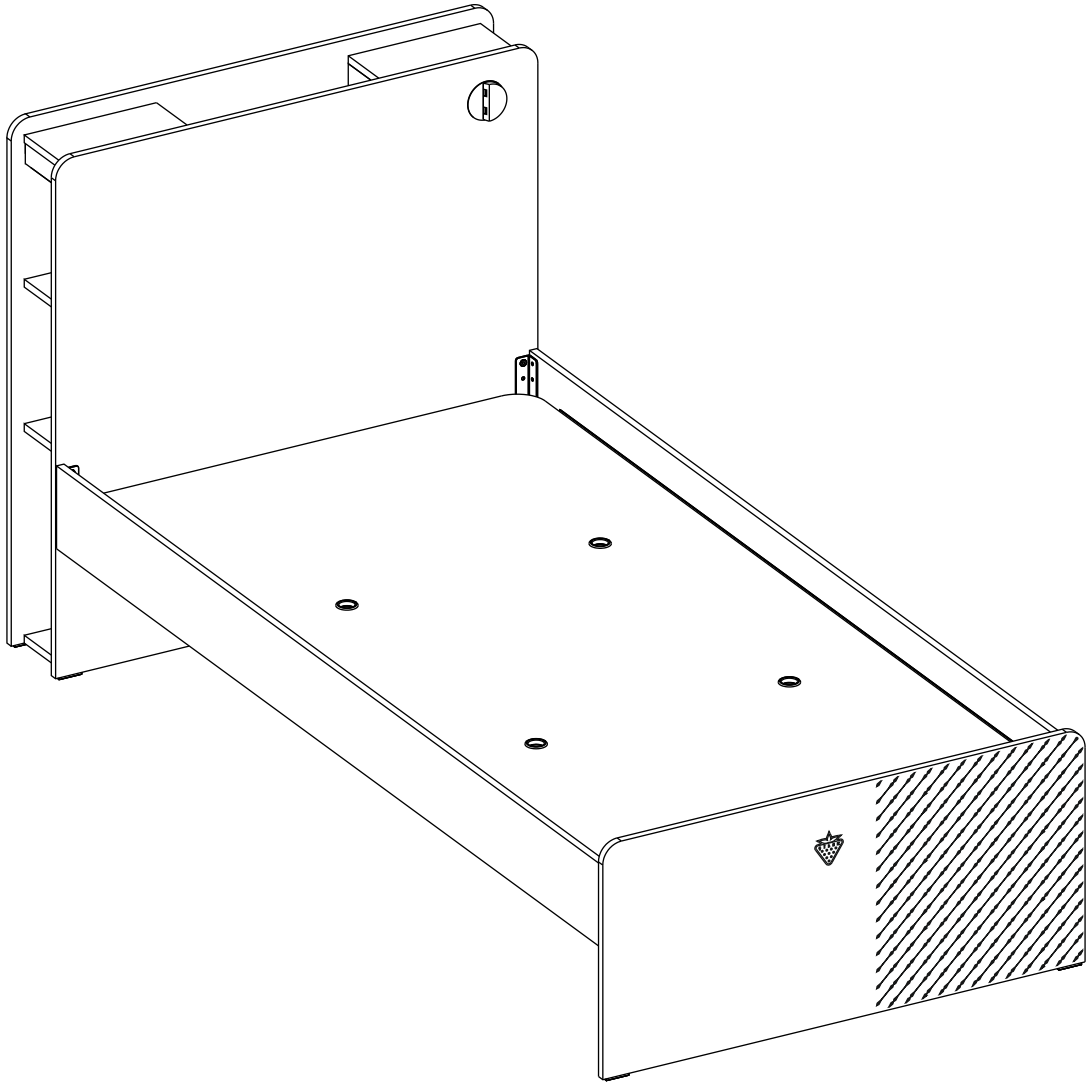

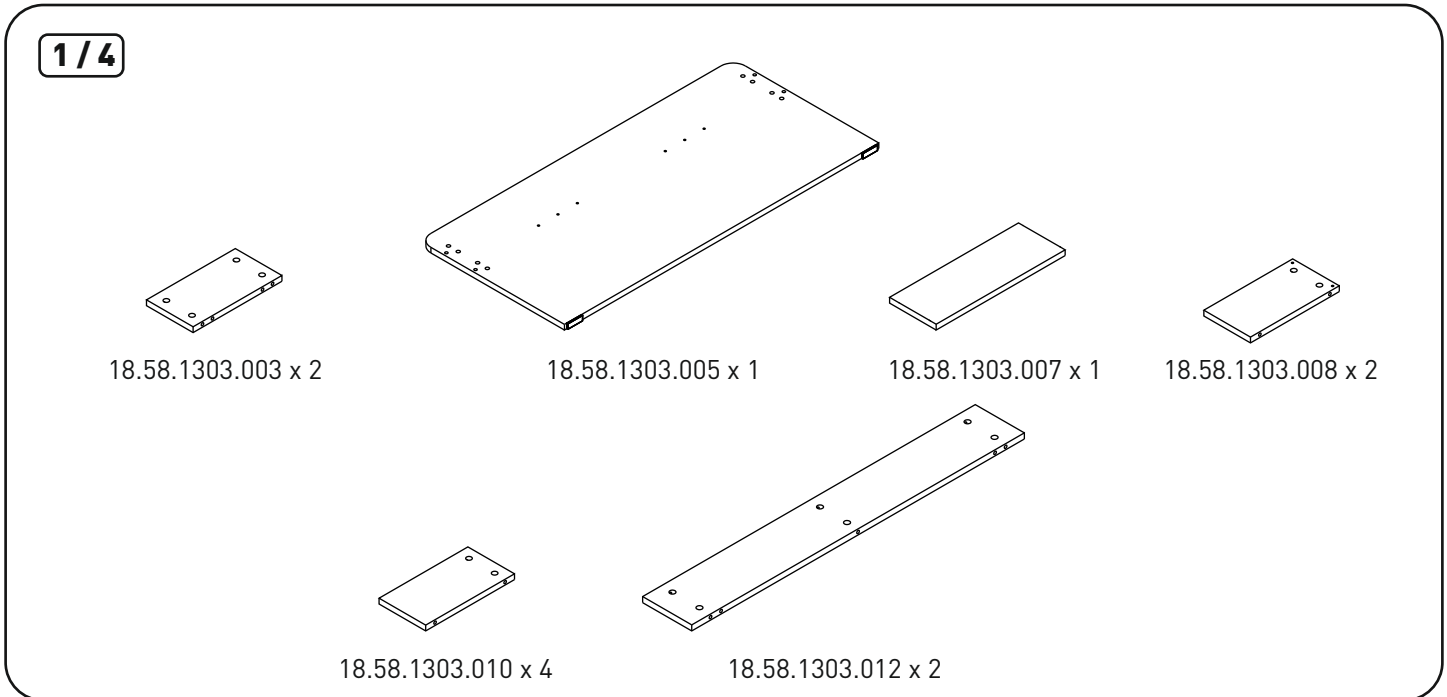

2/4

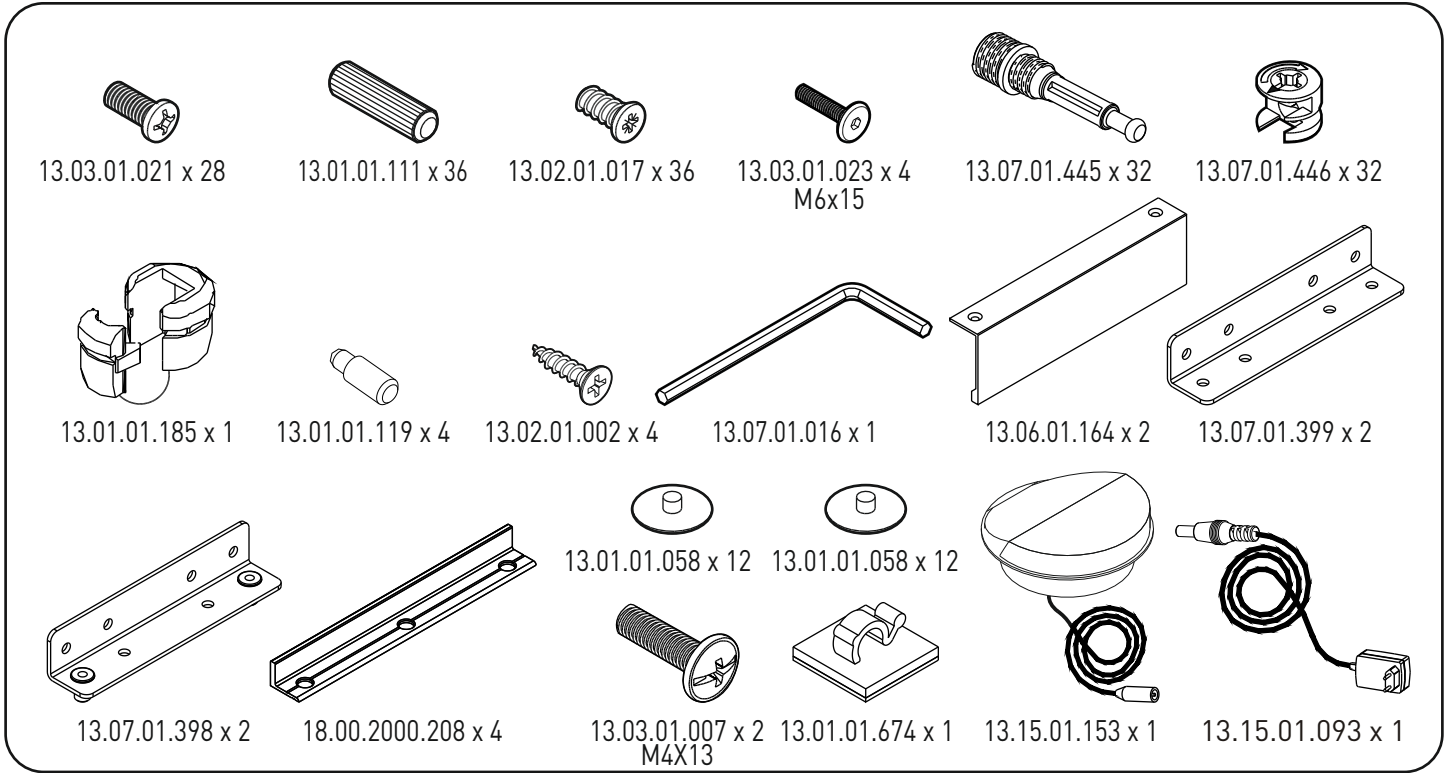
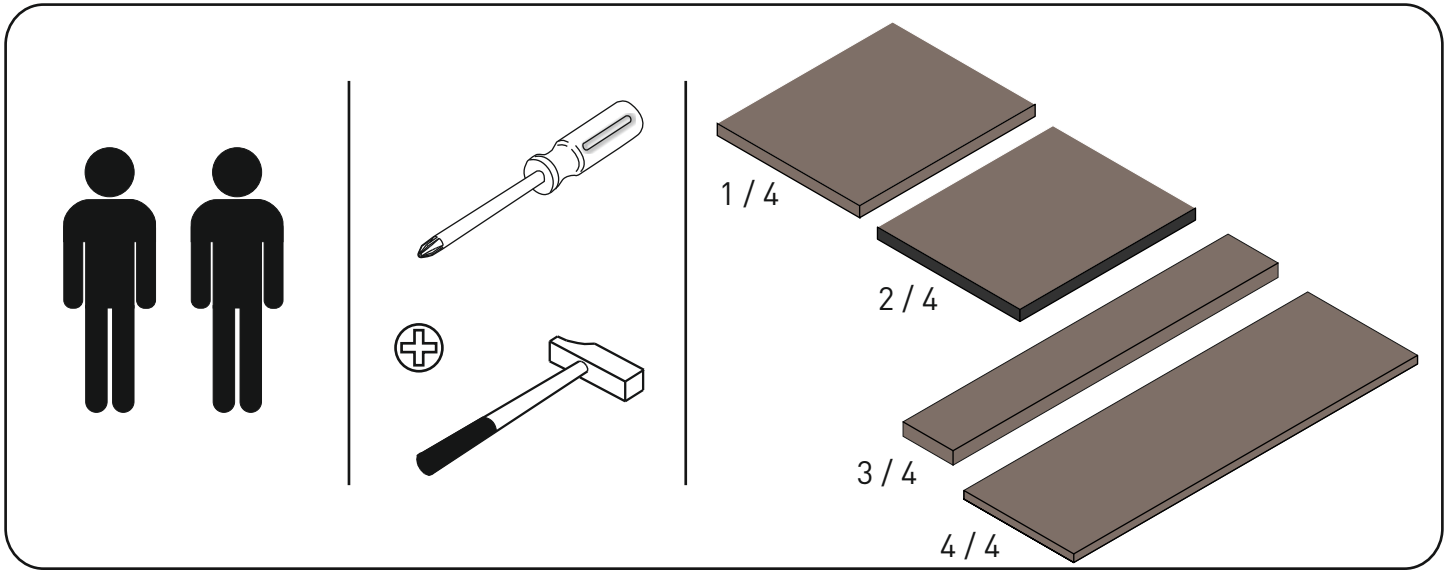
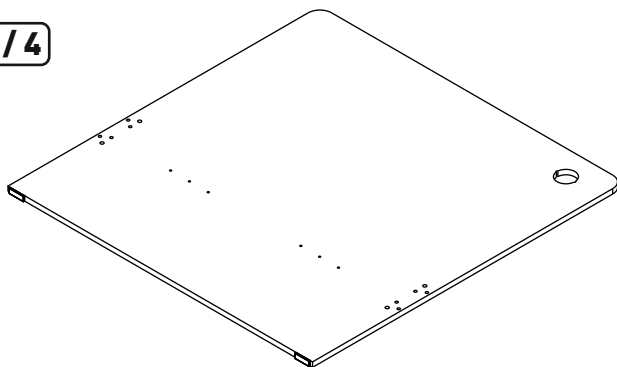

18.58.1303.001 x 1

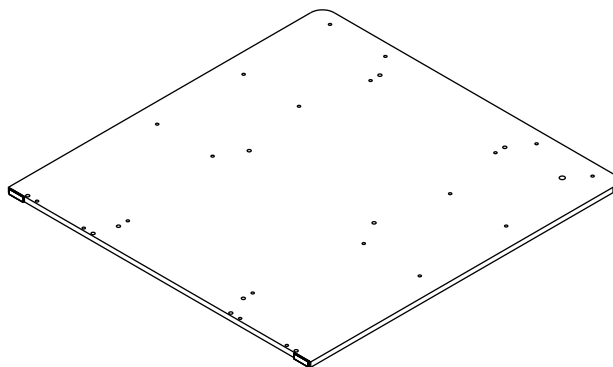

18.58.1303.002 x 1

3/4

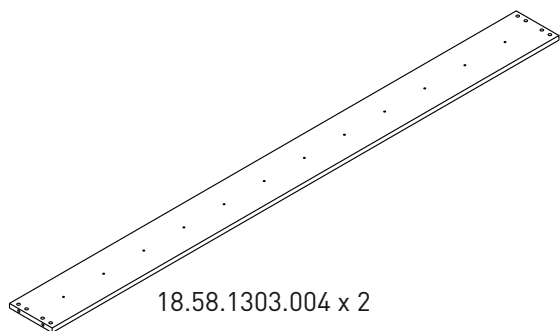

18.58.1303.004 x 2

4/4

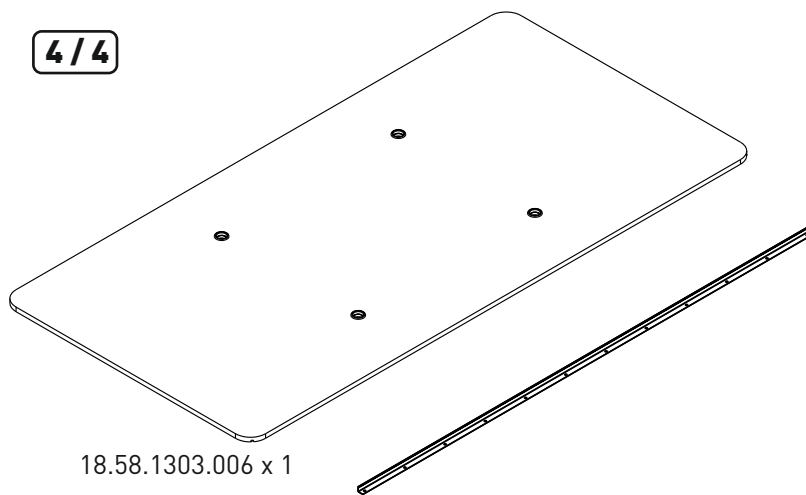

18.58.1303.006 x 1

18.00.2000.201 x 2

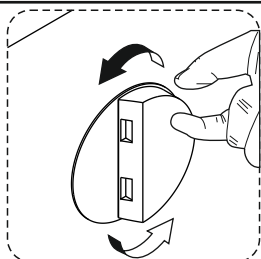

&

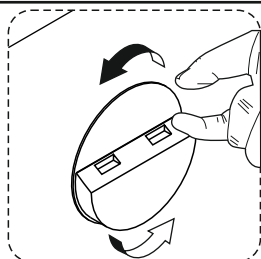

1

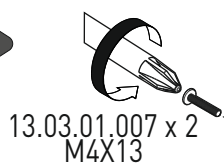

13.03.01.007 x 2
M4X13

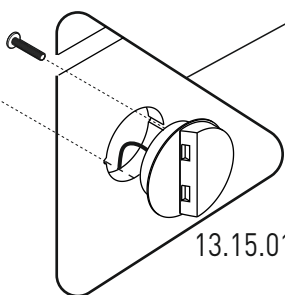

13.15.01.153 x 1

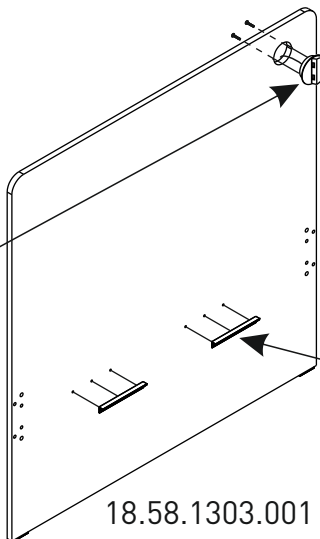

18.58.1303.001

18.00.2000.208 x 2

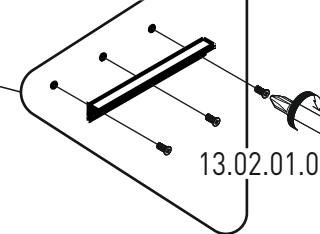

13.02.01.017 x 6

2

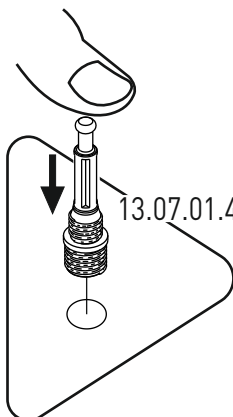

13.07.01.445 x 16

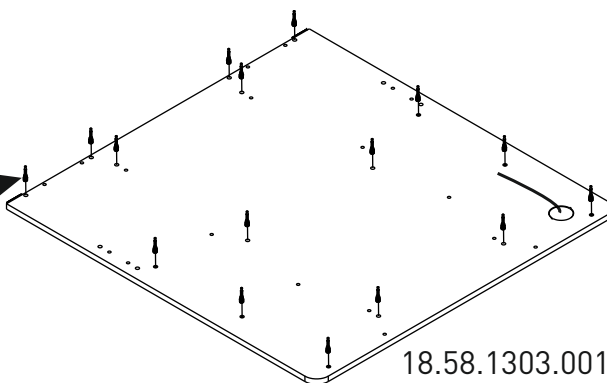

18.58.1303.001

3

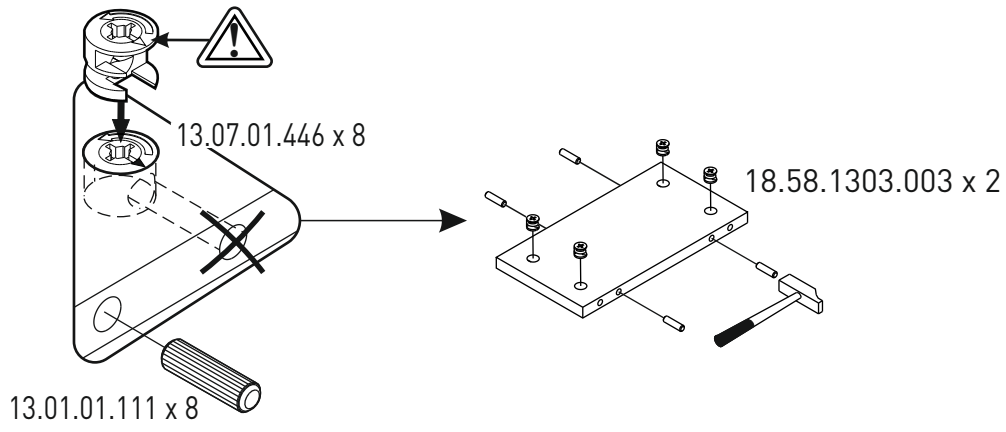

4

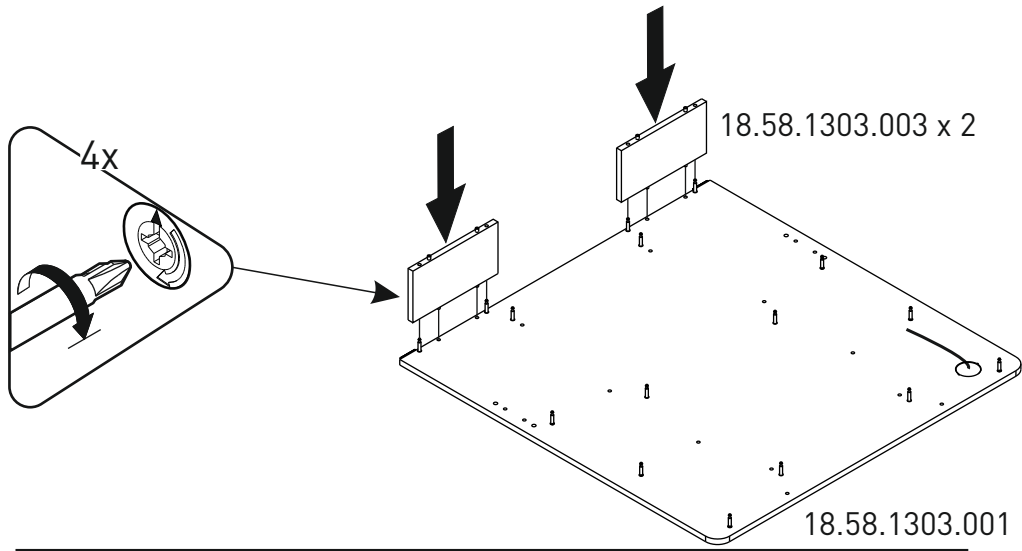

5

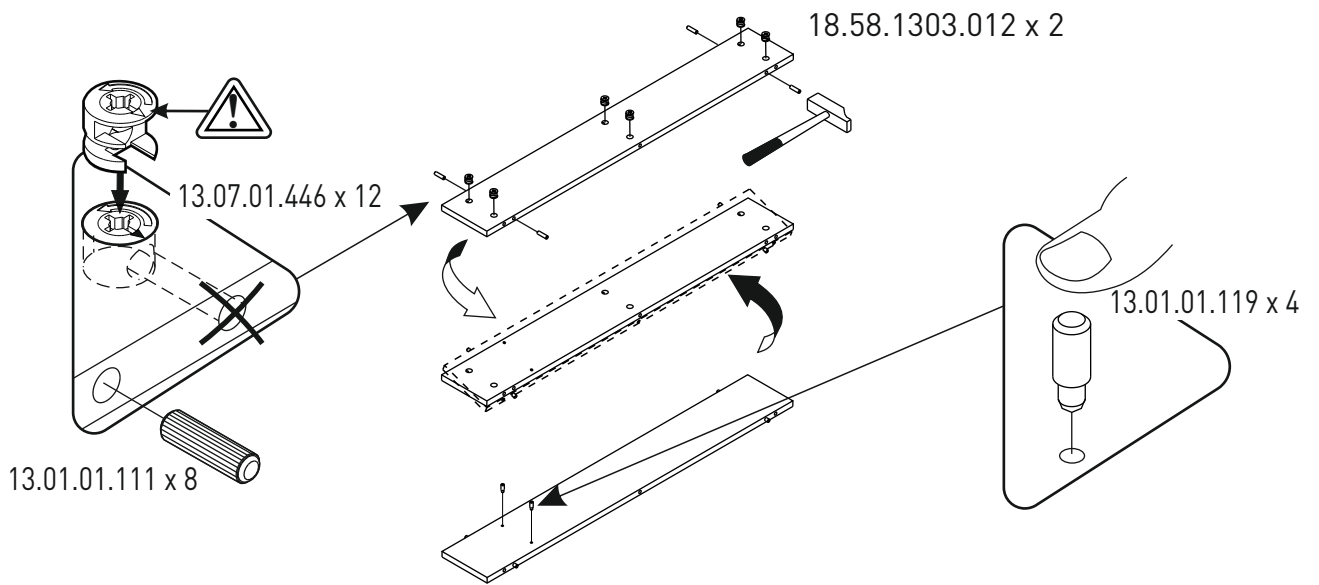

6

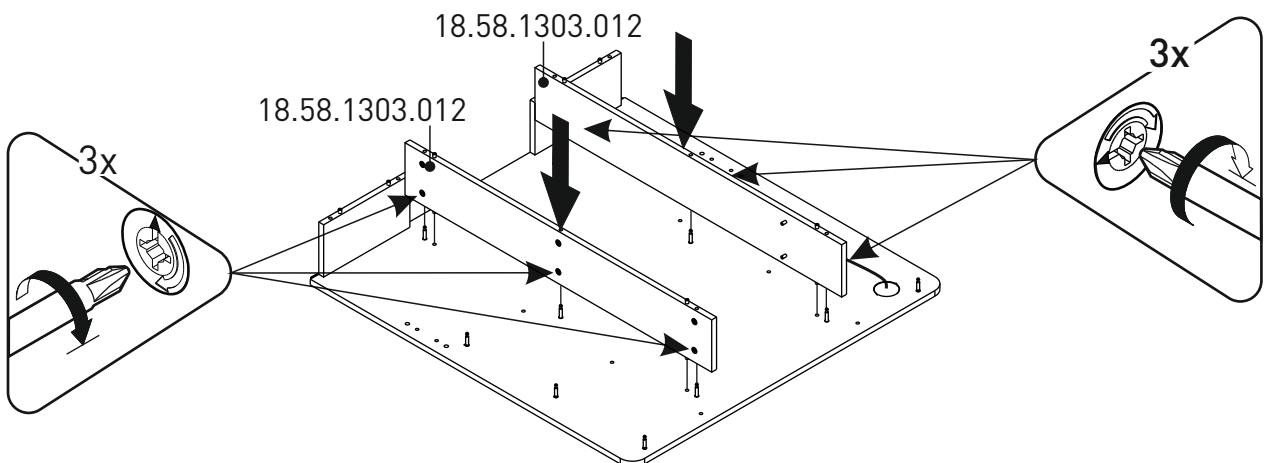

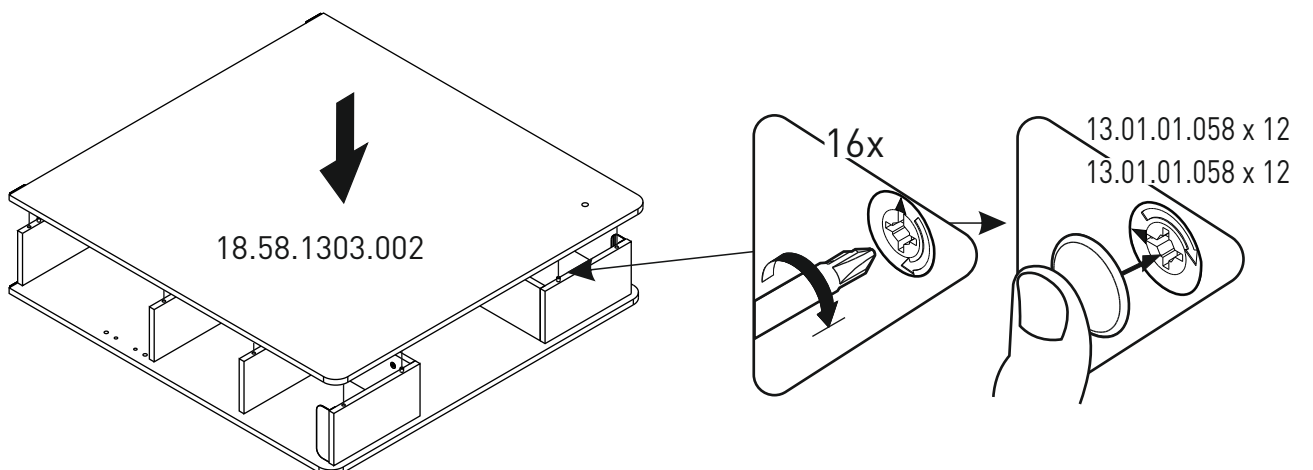
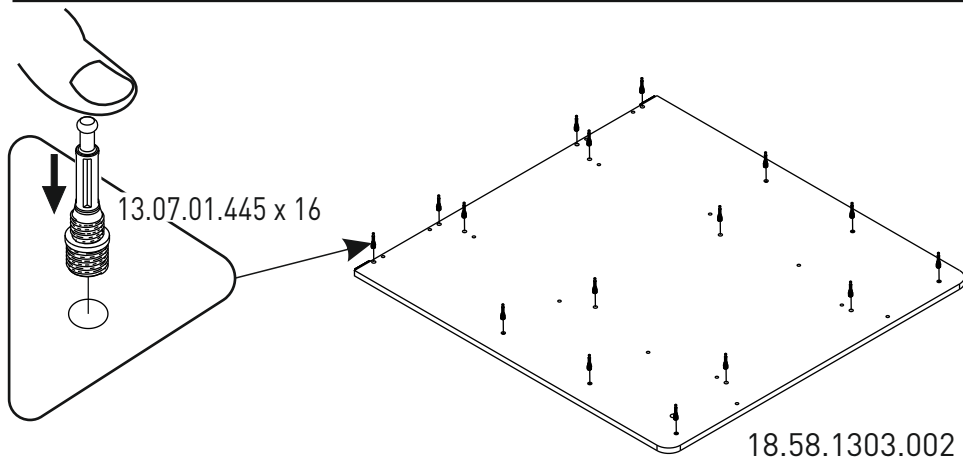
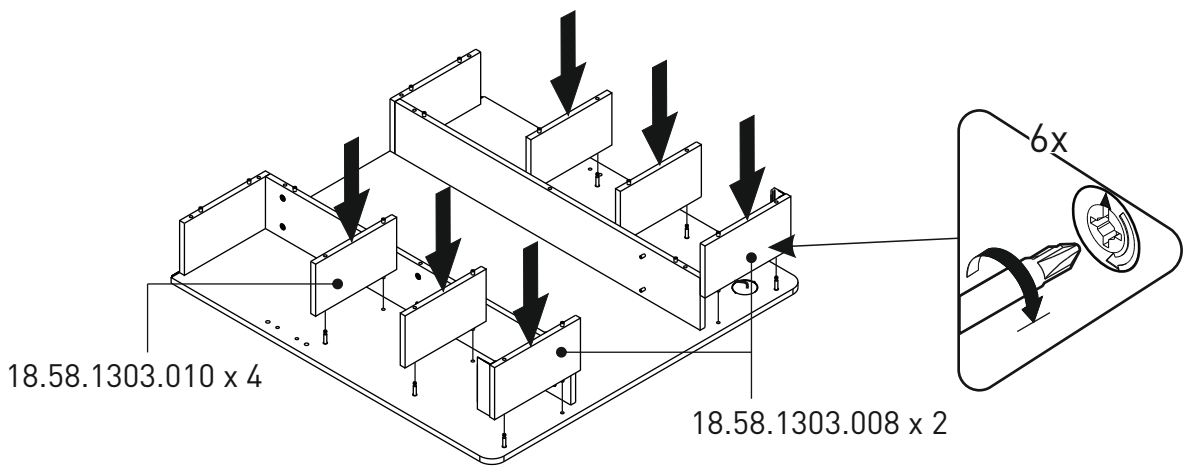
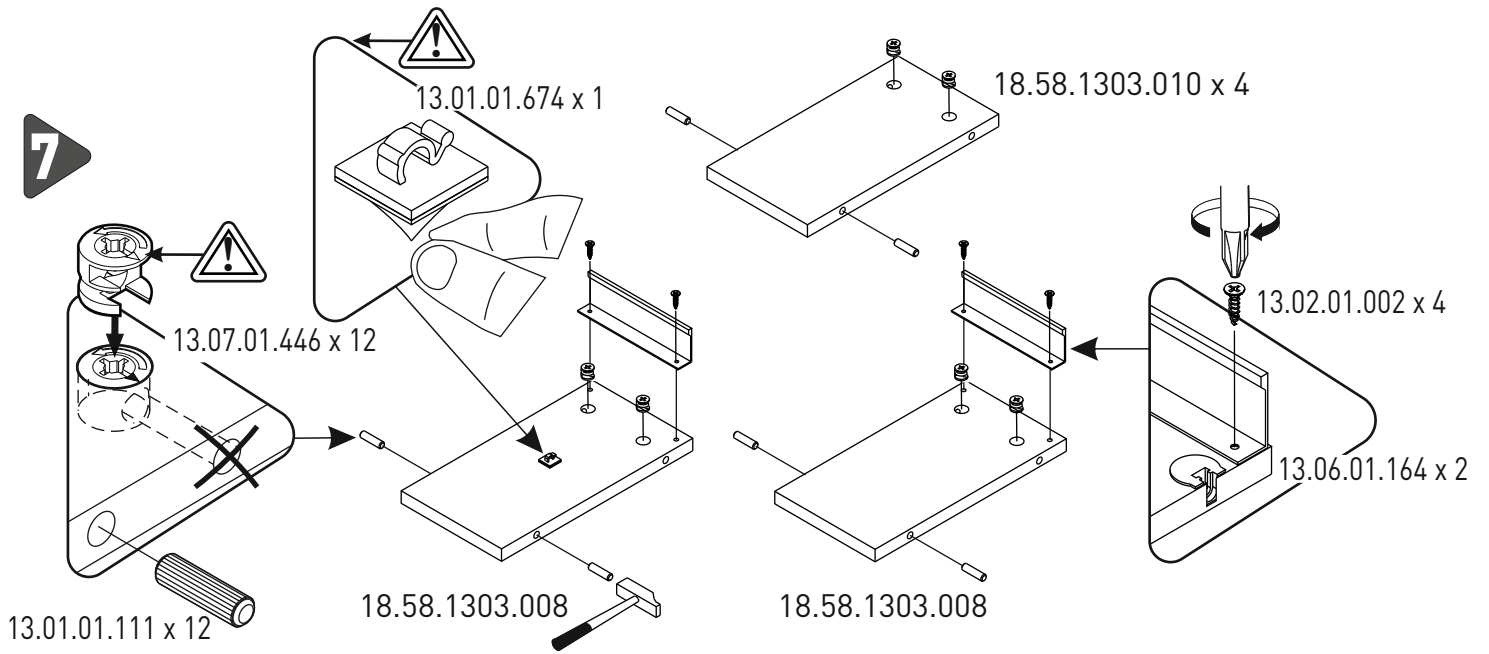

11

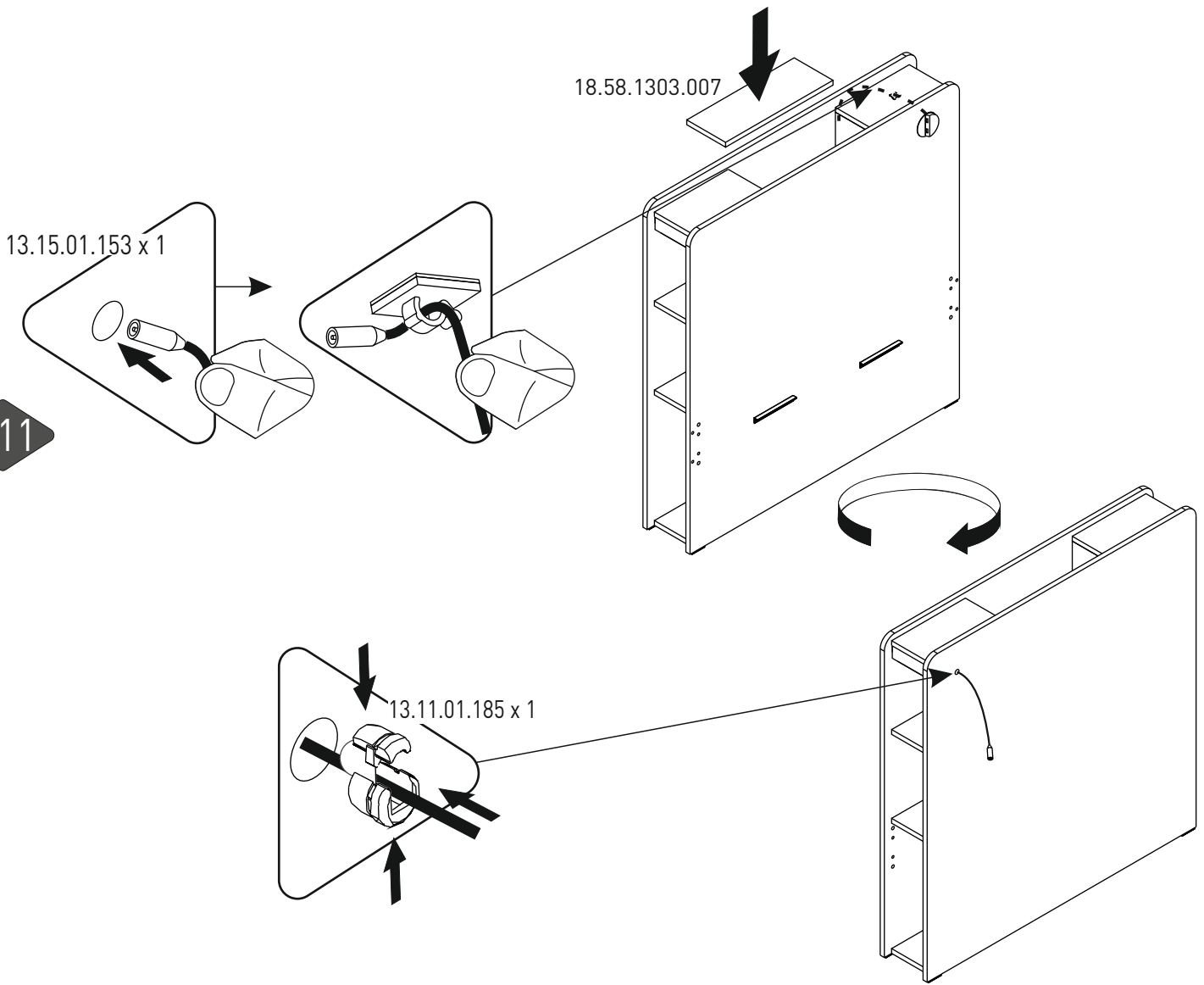

12

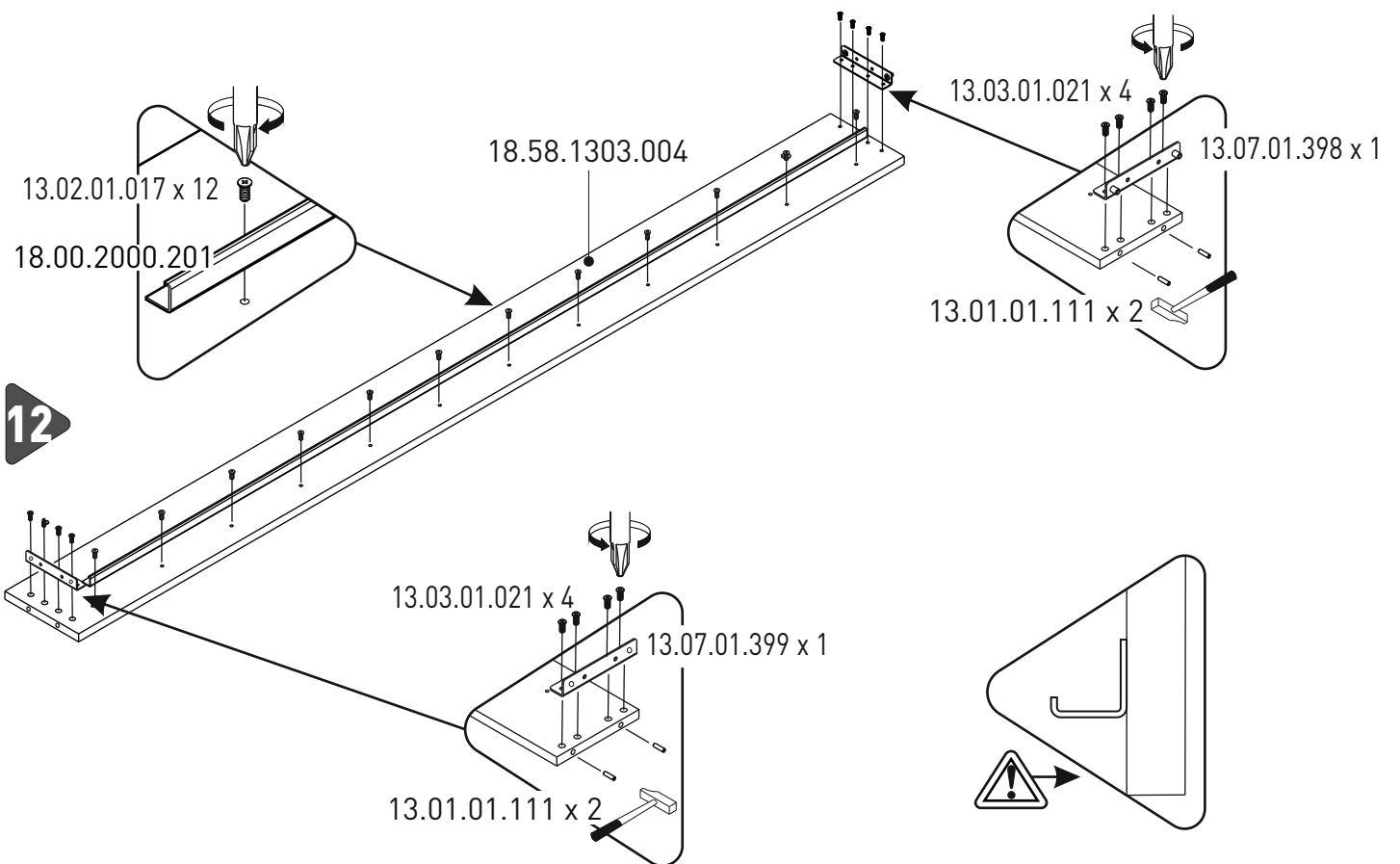

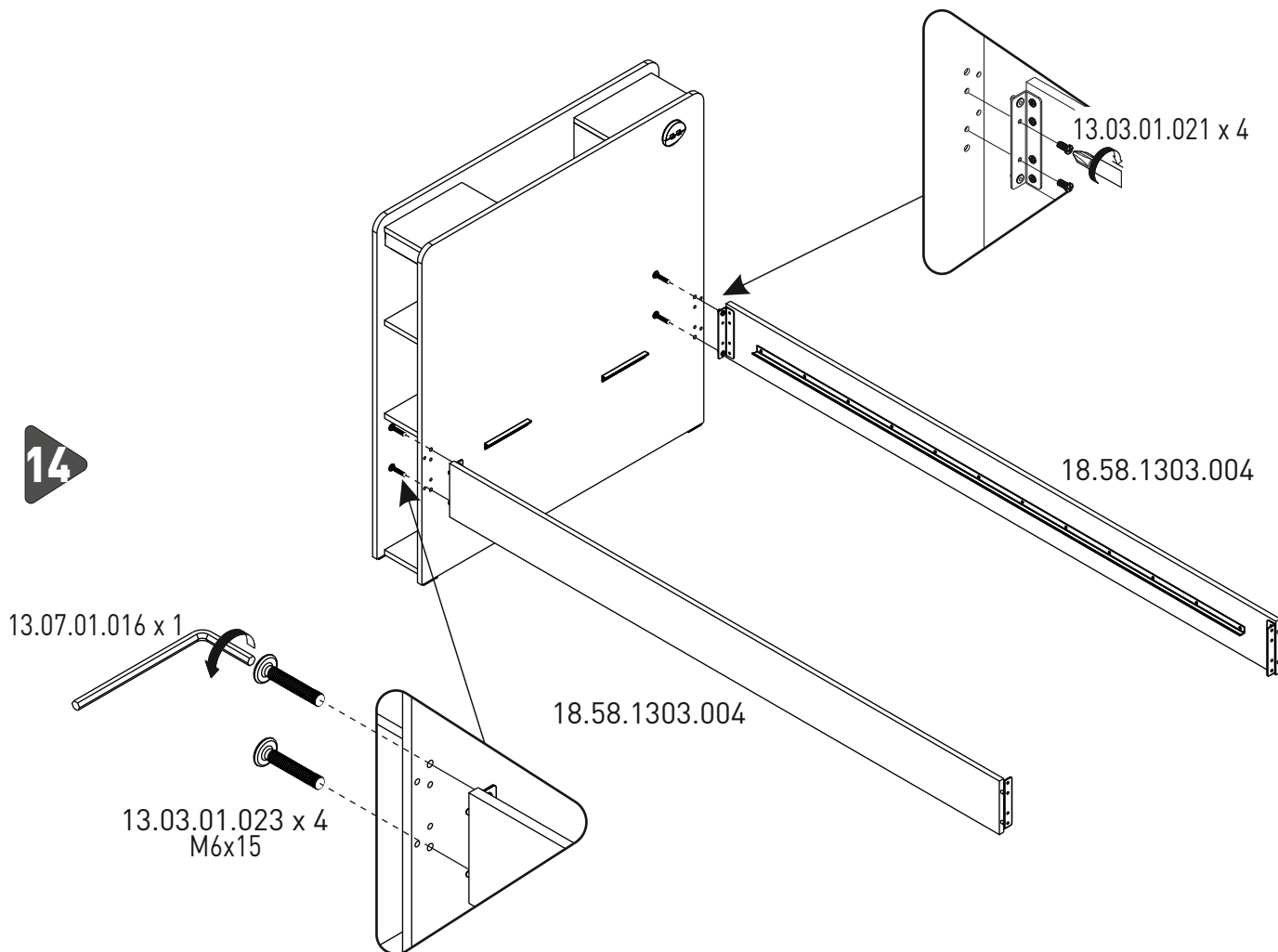
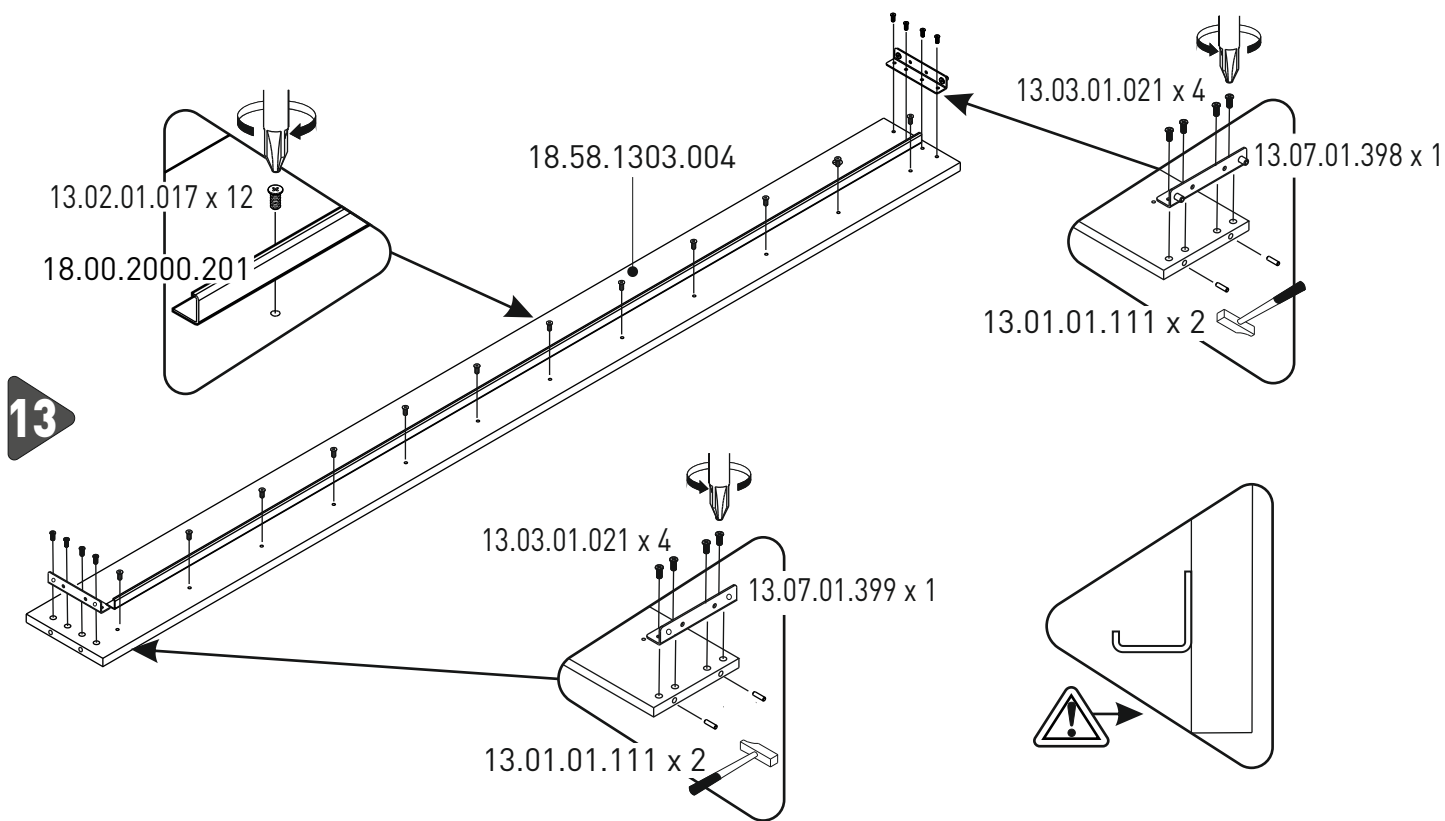

15

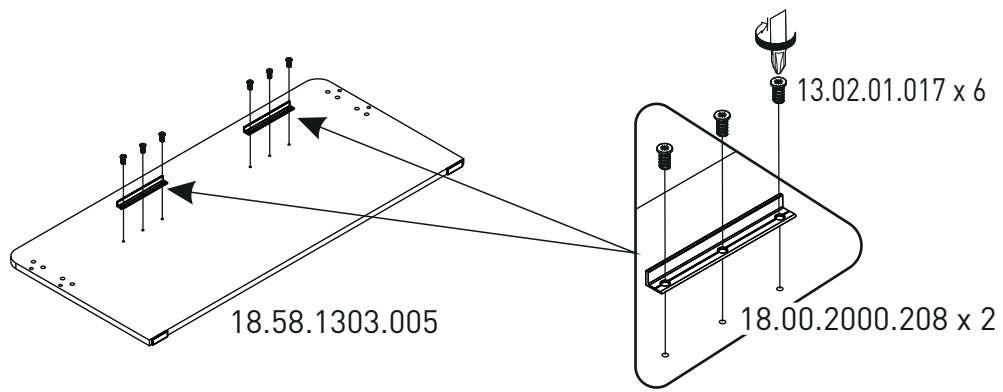

16

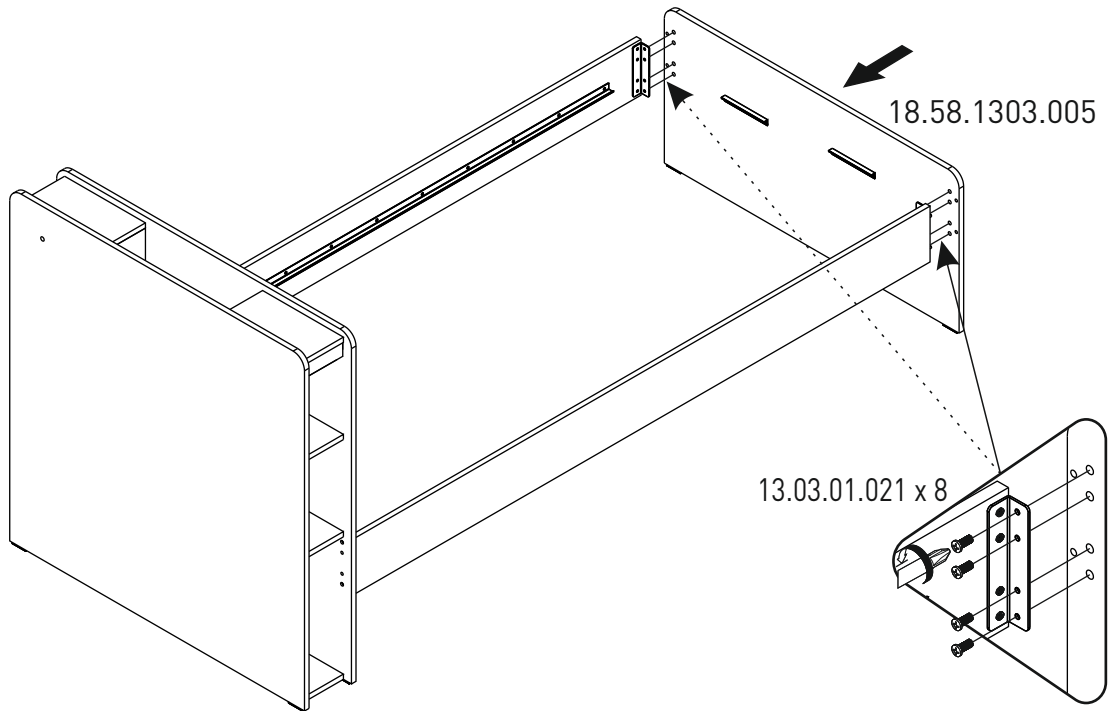

17

