

# ASSEMBLY INSTRUCTION

A-1pc

B-2pcs

C-4pcs

D-16pcs

E-1pc

F-4pcs

G-16pcs

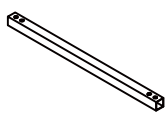
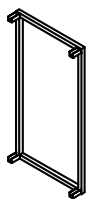
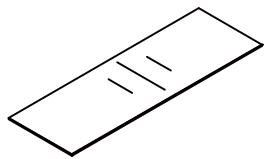

1

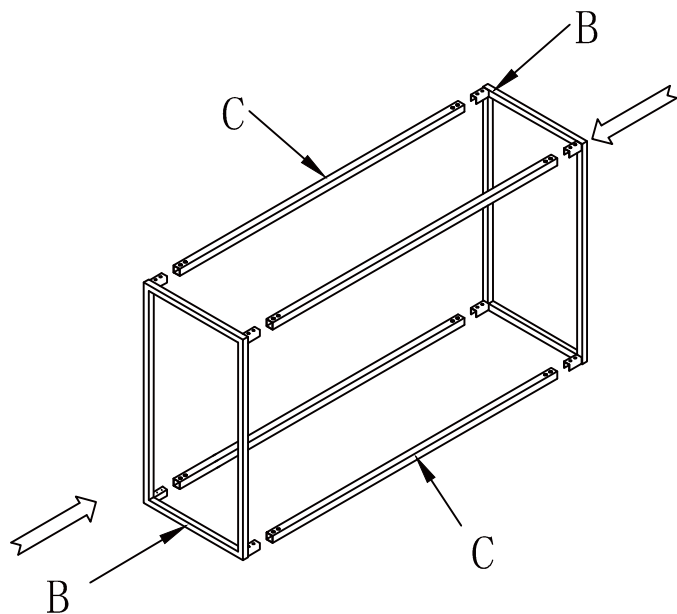

2

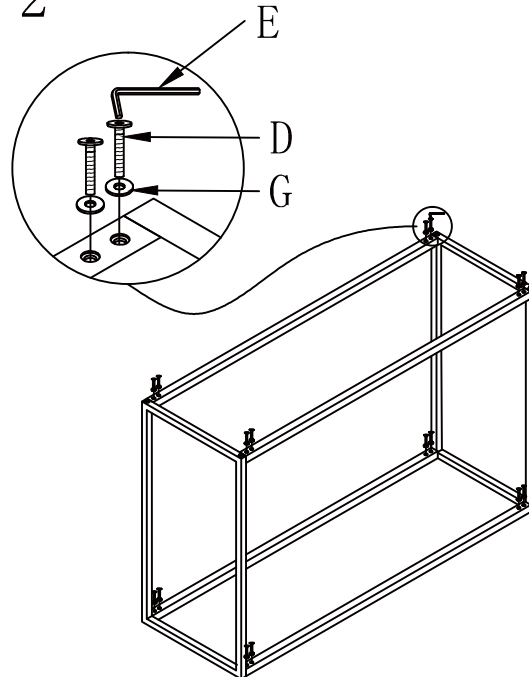

3

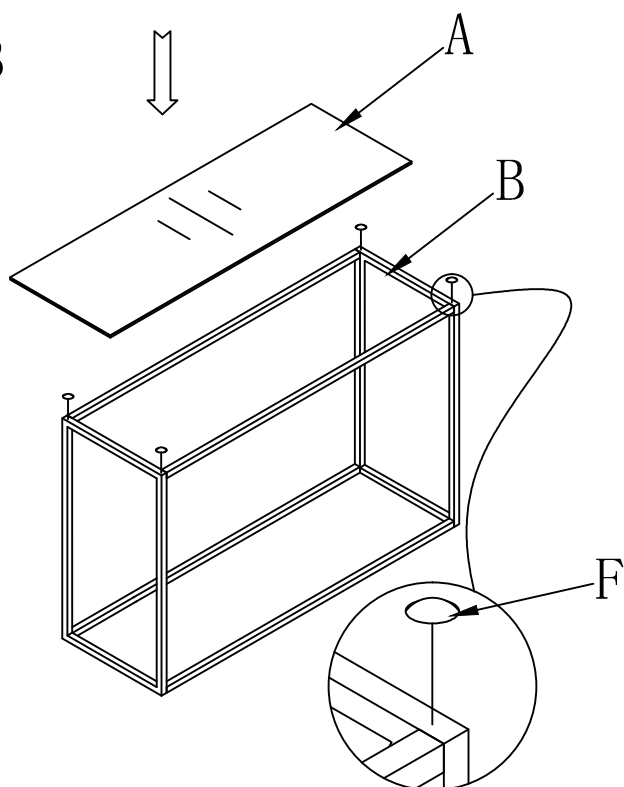

4

