

20.21.1800.00

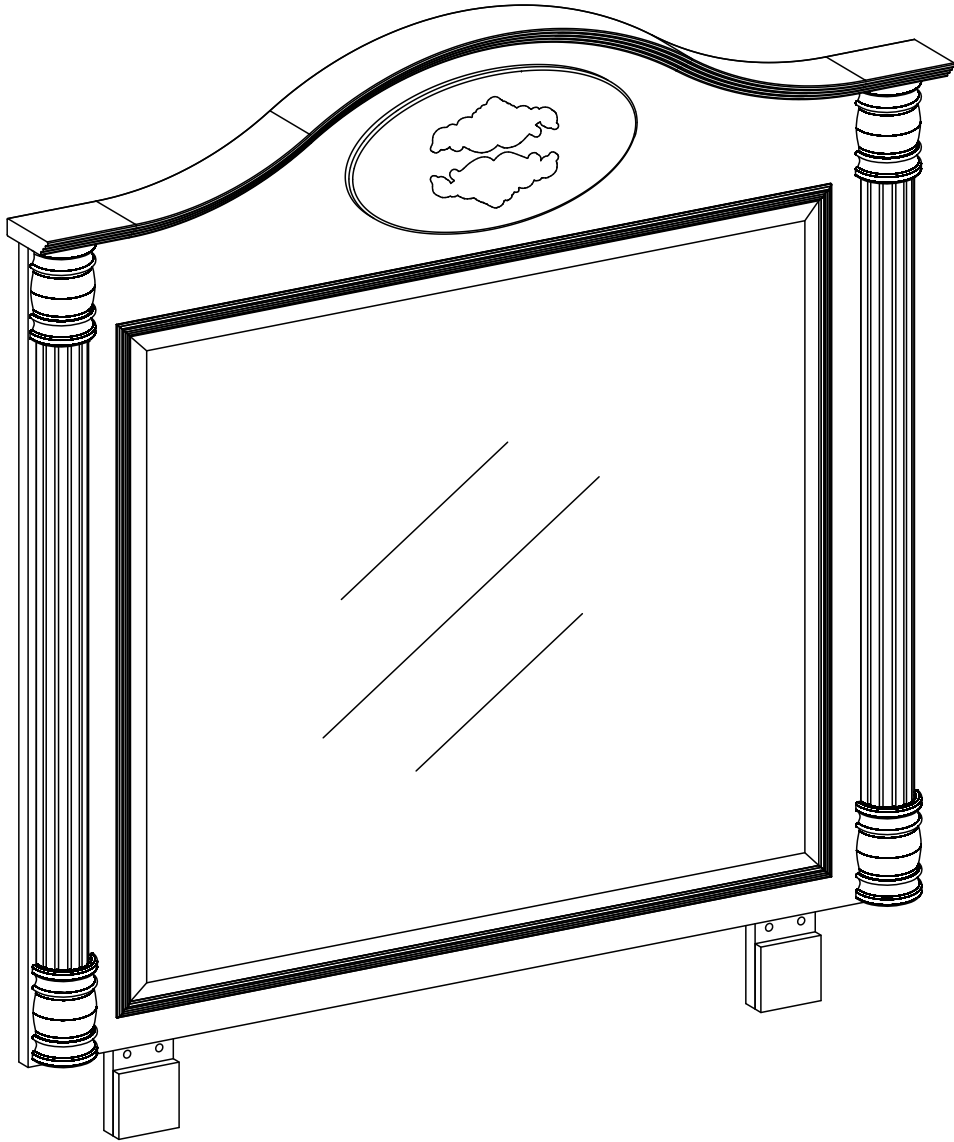

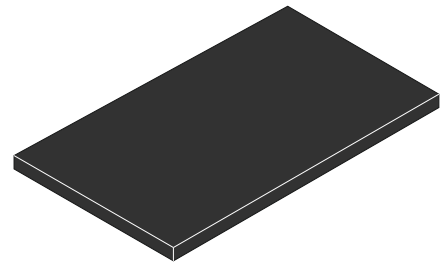

1 / 1

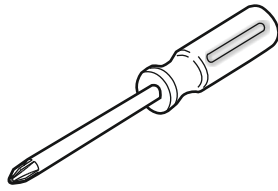
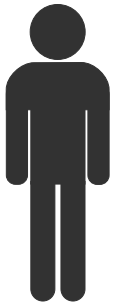
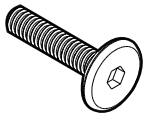

13.03.01.027 x 4

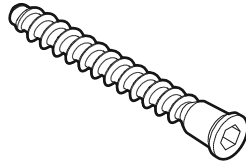

13.02.01.019 x 4

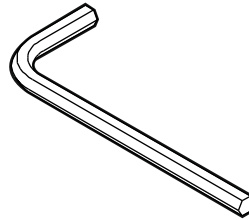

13.07.01.016 x 1

1 / 1

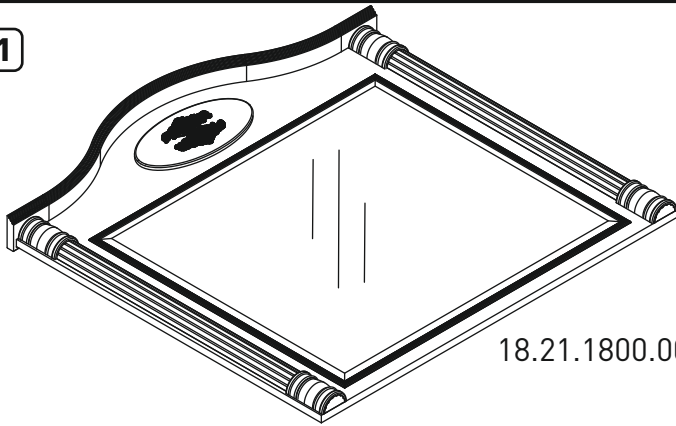

18.21.1800.001 x 1

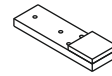

18.21.1800.005 x 2

