

20.76.1102.00

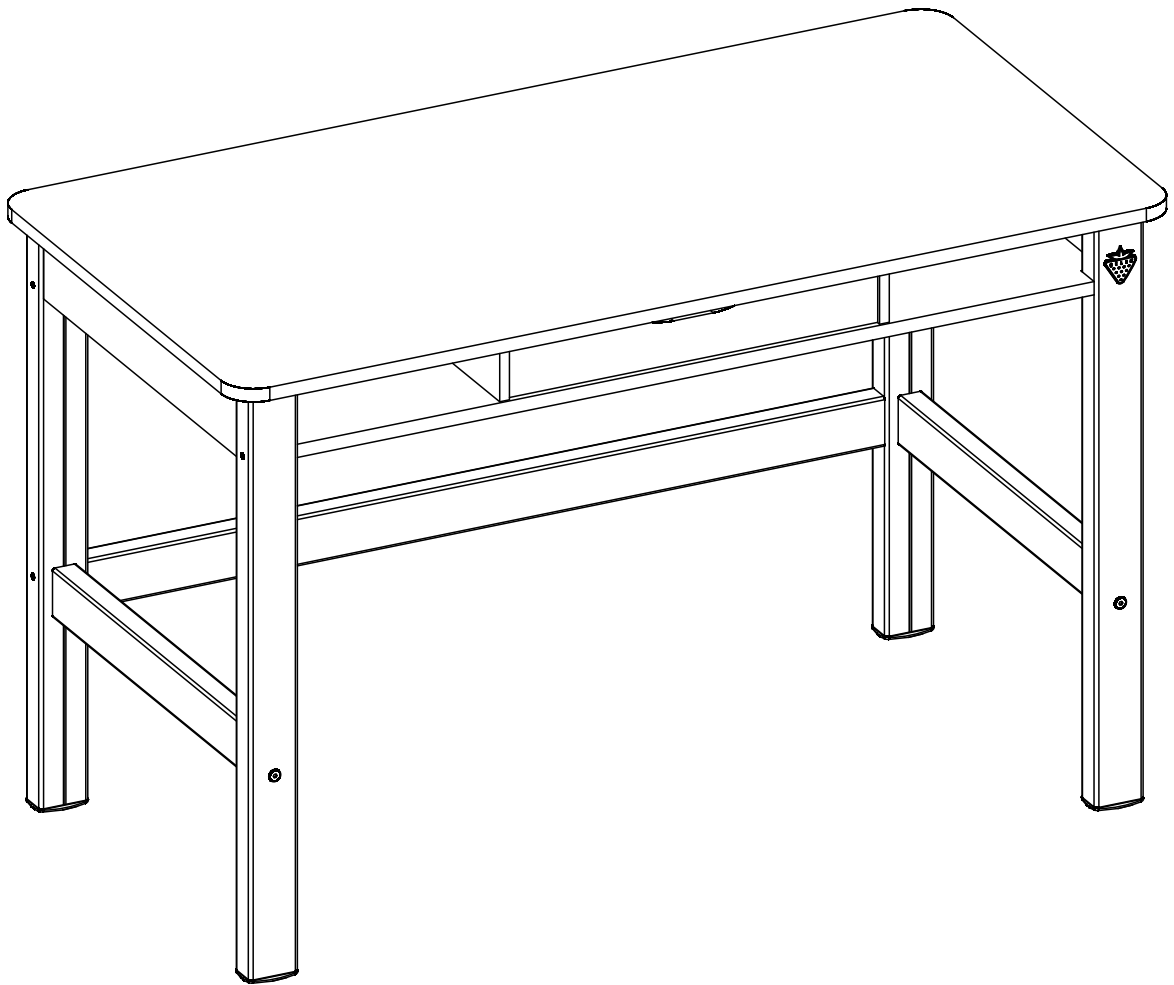

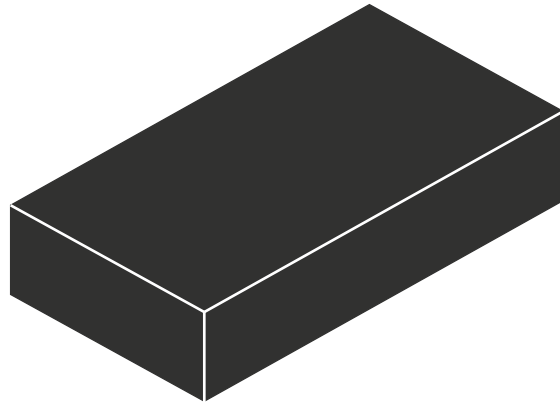

1 / 1

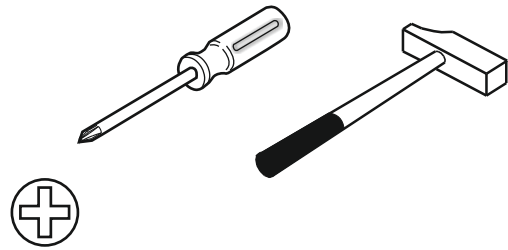
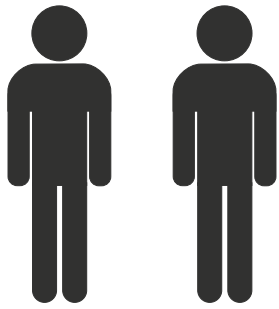
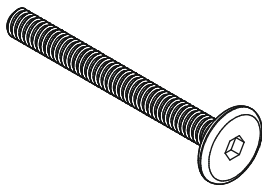

M6X55
13.03.01.039 x 6

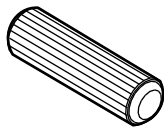

13.01.01.111 x 2

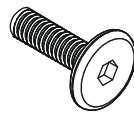

M6X30
13.03.01.029 x 4



13.01.02.070 x 2

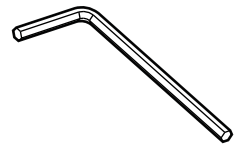

13.07.01.016 x 1

1 / 1

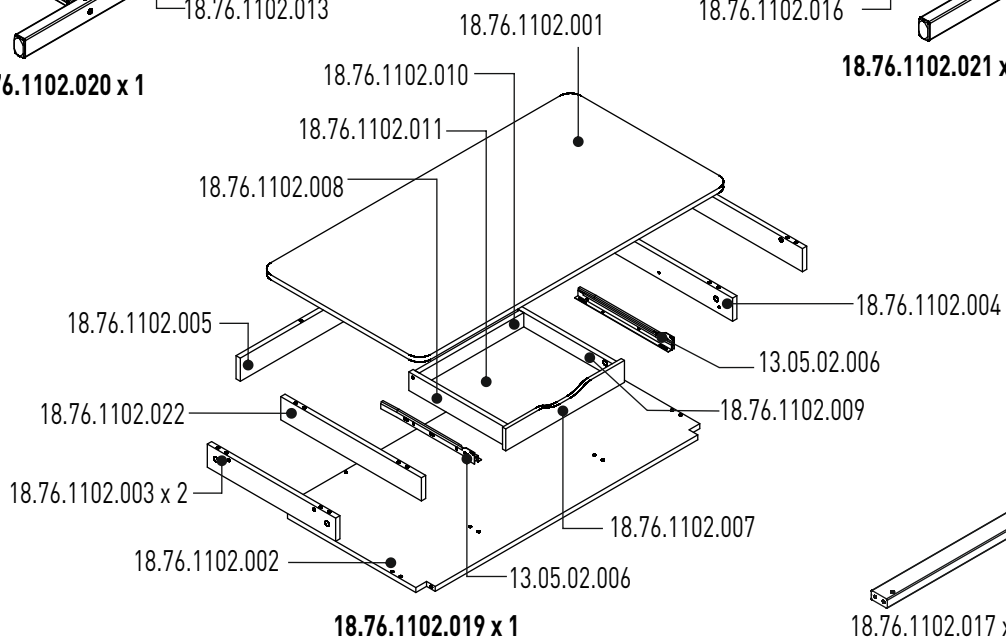
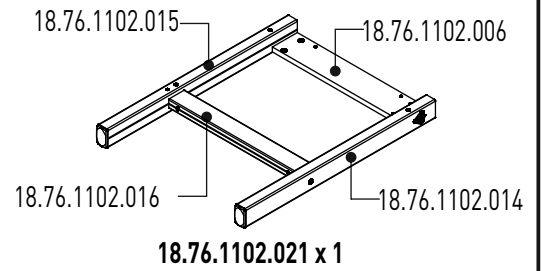
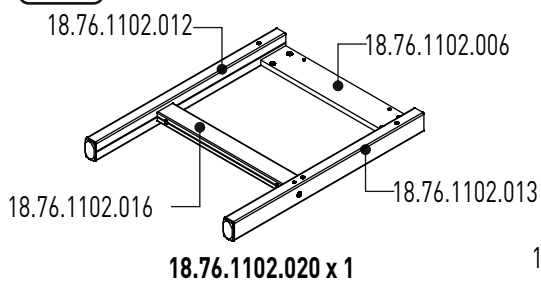

1

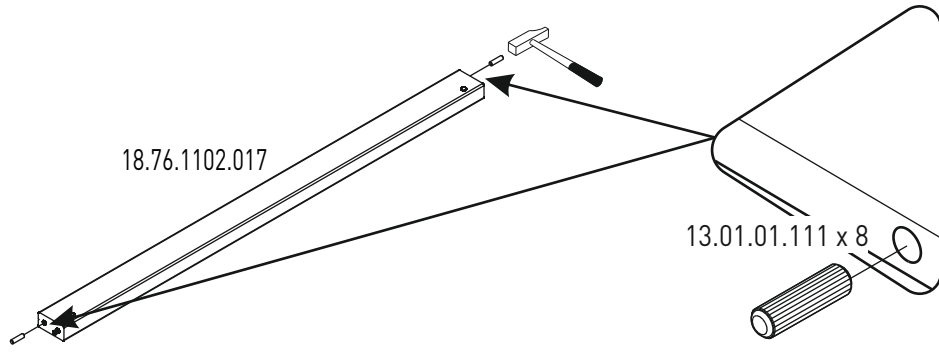

2

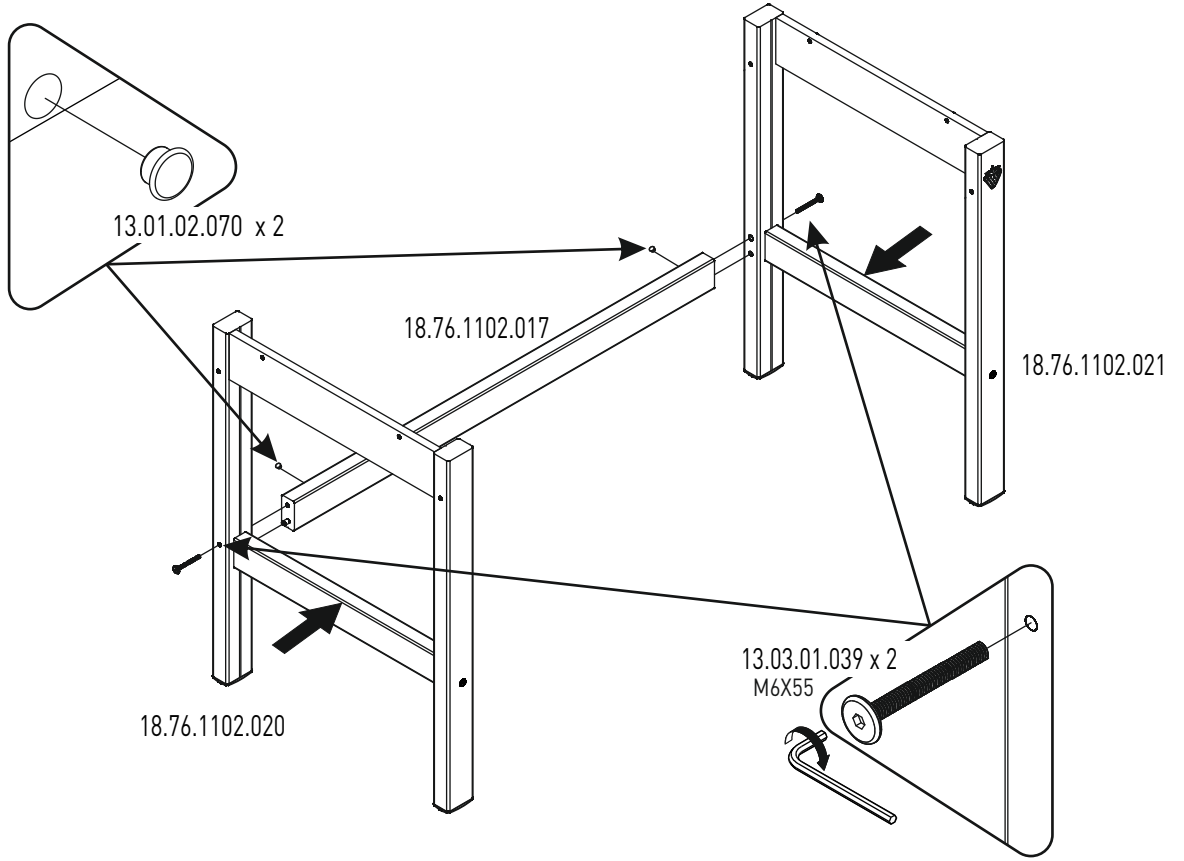

3

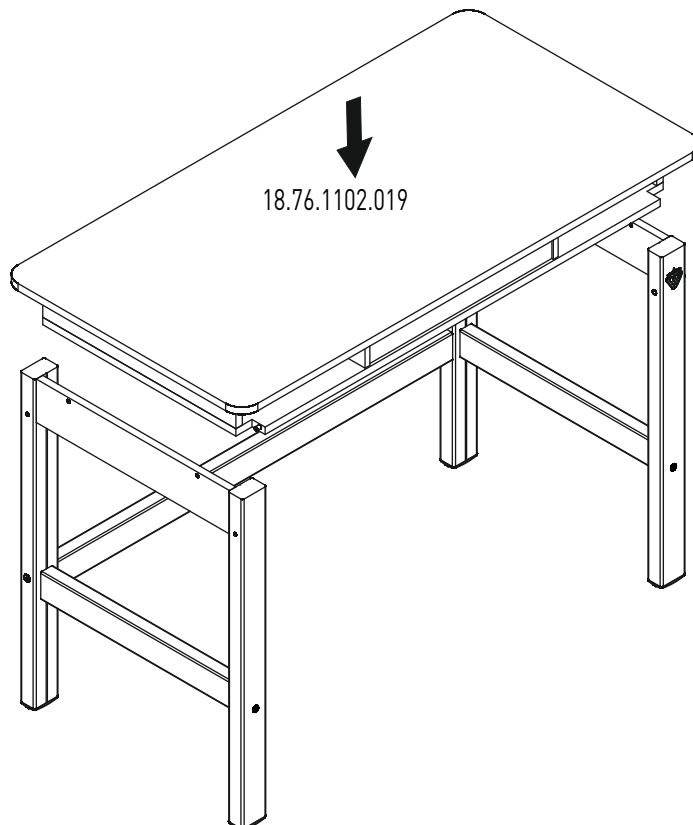

4

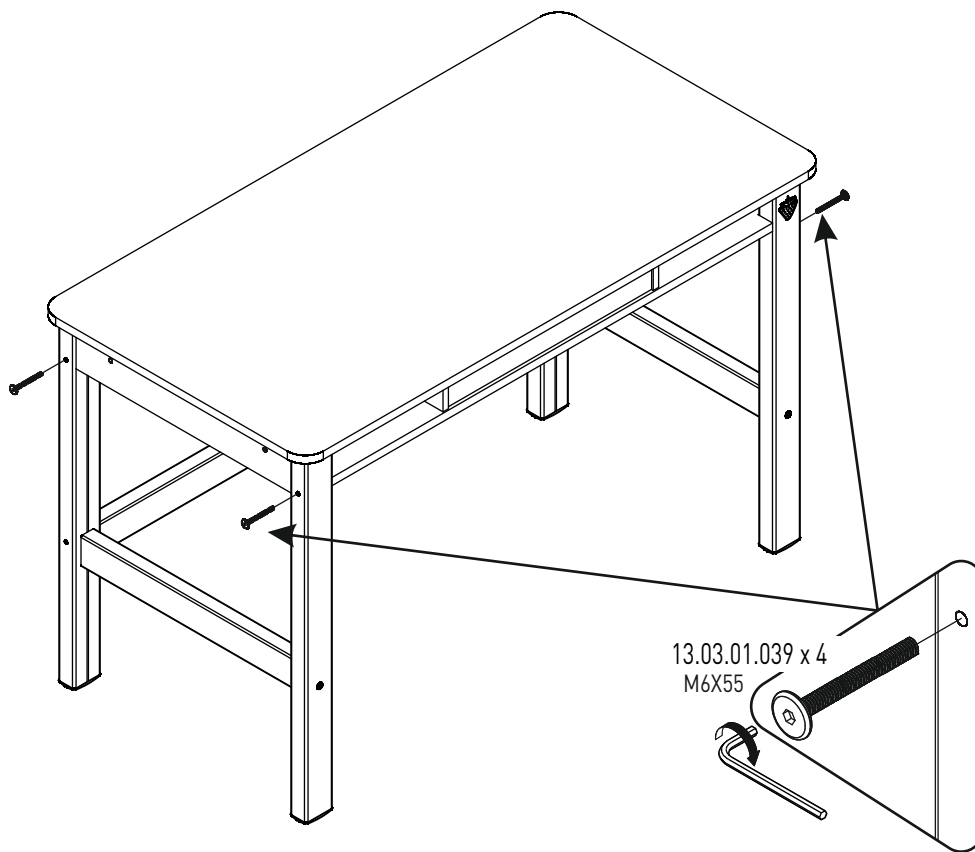

5

