

MDI. SB. ZR. 7

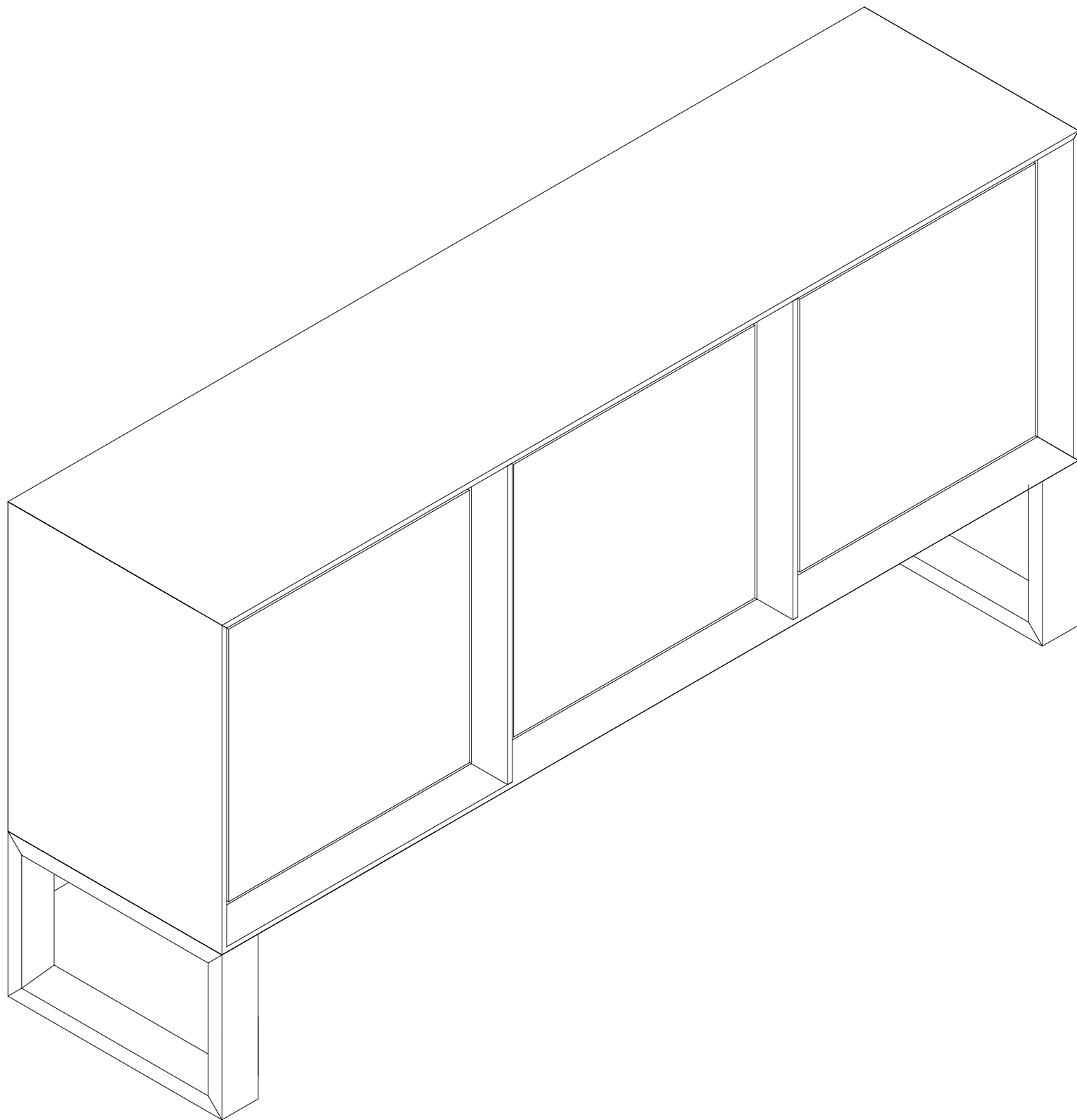

# MDI. SB. ZR. 7

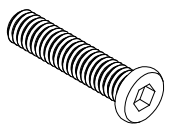
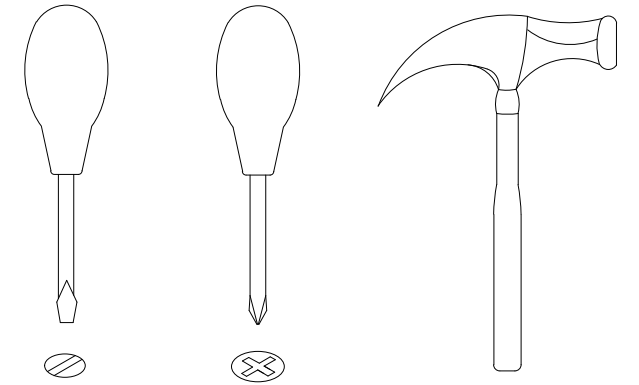
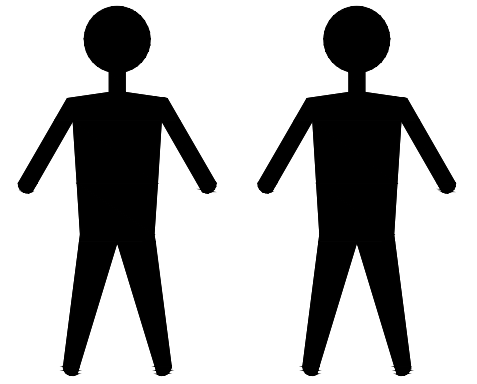

A x10  
Spec: 5/16\*L45

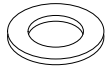

B x10  
Spec:  $\phi 8.2 * \phi 14$

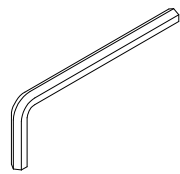

C x1  
Spec: 5#

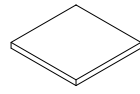

D x4  
Spec: 40\*40

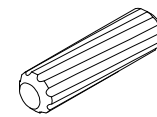

E x2  
Spec:  $\phi 10 * 40$

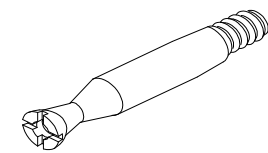

F x9  
Spec:  $\phi 7 * L48$

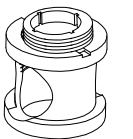

G x9  
Spec:  $\phi 15 * H15$

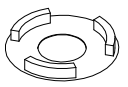

H x9  
Spec:

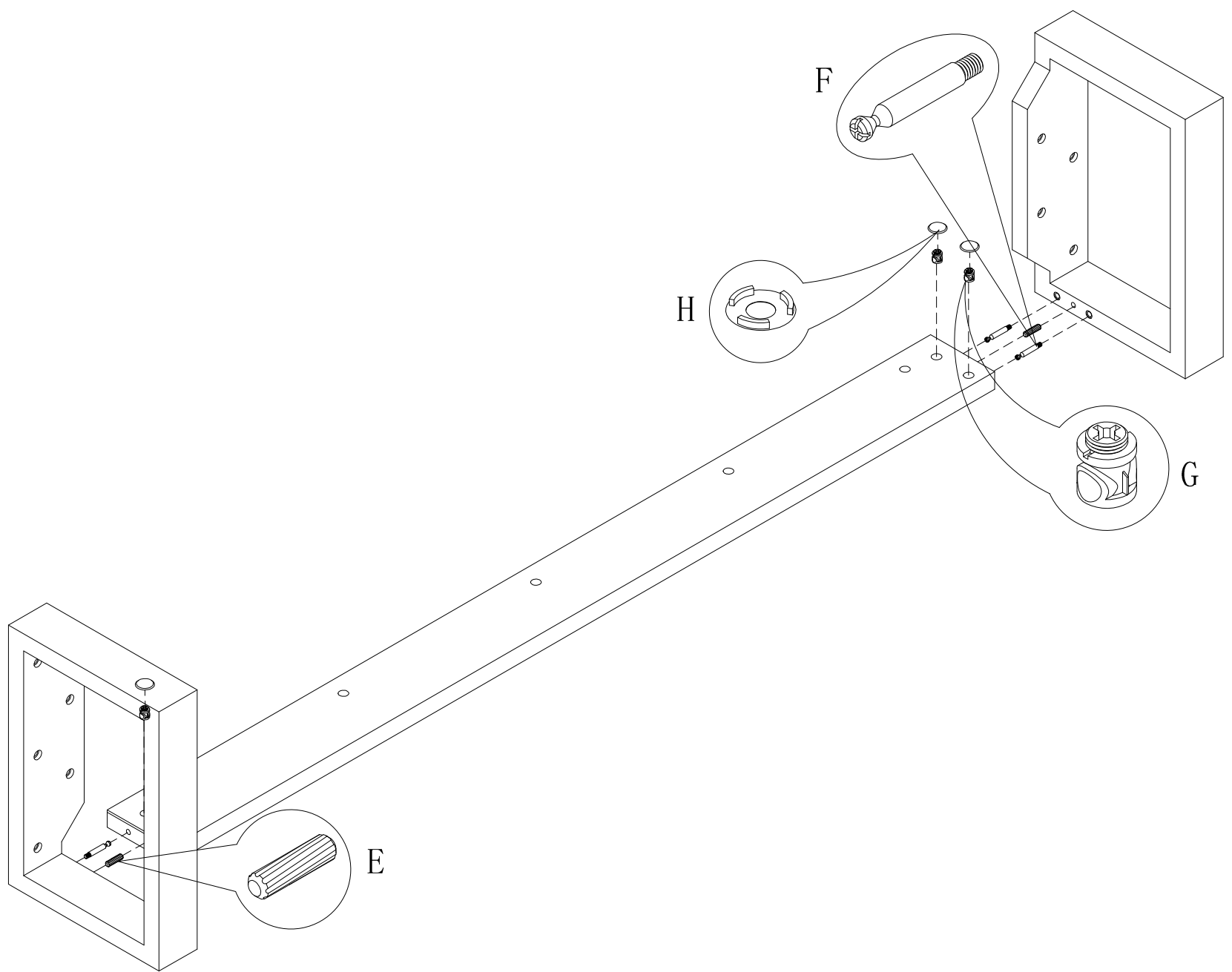

1

2

