

20.77.1701.00

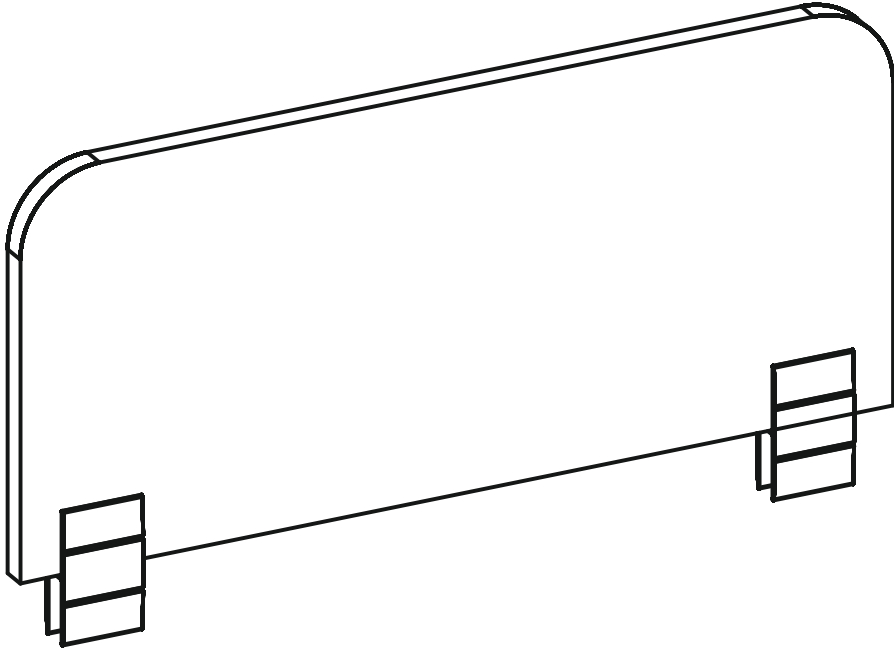

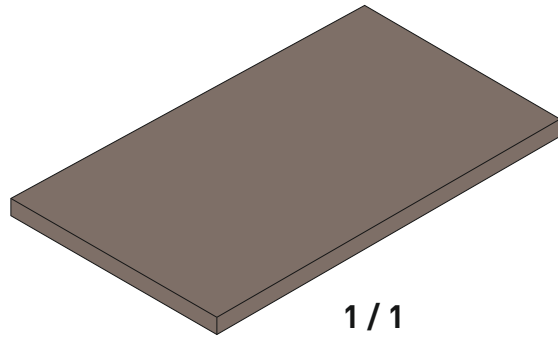
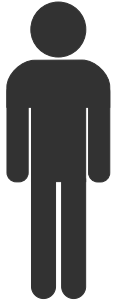

1 / 1

1 / 1

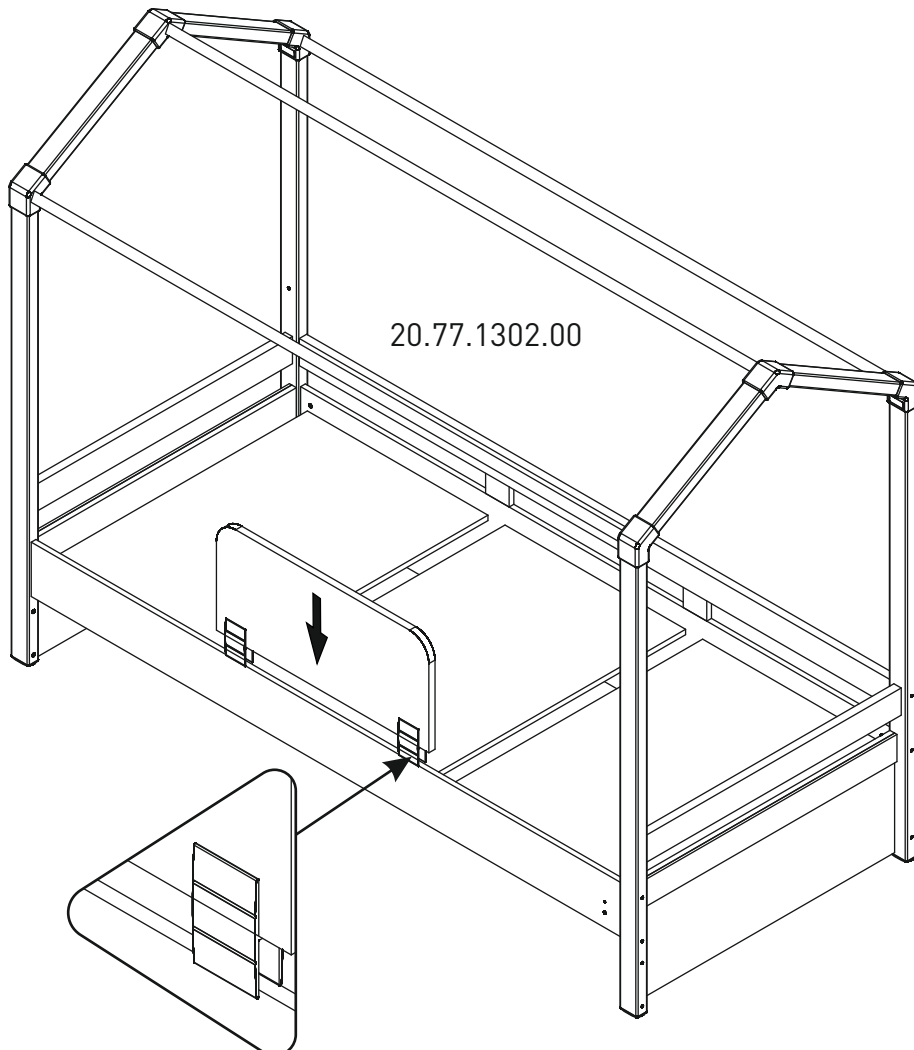
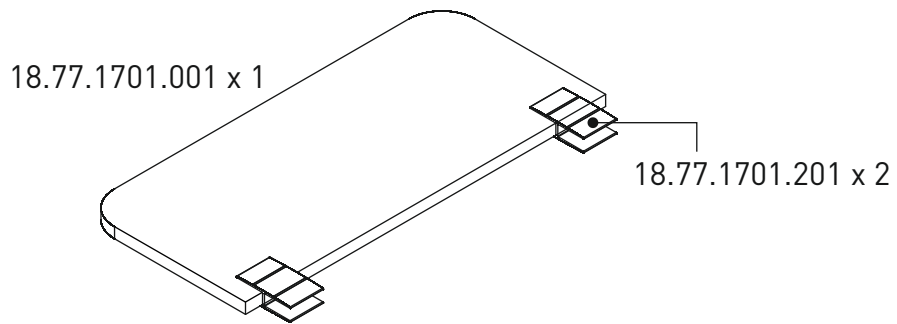

1